

300mA LDO

Monolithic IC MM3571 Series

Outline

This IC is a 300mA Low dropout regulator IC with a prevention circuit of rush current. No load input current is 25 μ A typ, and it reduce transient drop in voltage with high speed response circuit. A rush current prevention circuit can control rush current at start up.

Features

1. Maximum operating voltage	6.5V
2. Output current	300mA
3. No load input current	25 μ A typ.
4. Input current (OFF)	1 μ A max.
5. Output voltage range	1.0~5.0V
6. Output voltage accuracy	\pm 1%
7. Dropout voltage	0.62V typ. (I_{OUT} =300mA)
8. Line regulation	0.1%/V max.
9. Load regulation	30mV typ. (I_{OUT} =1~300mA)
10. Ripple rejection	70dB typ. (f=1kHz)
11. Output Capacitor	0.47 μ F
12. ON/OFF control	

Package

SC-82ABB
SOT-25A
SOT89-5A

Applications

1. Mobile phone, Smart phone
2. Digital camera
3. Game equipment
4. Tablet

Block Diagram

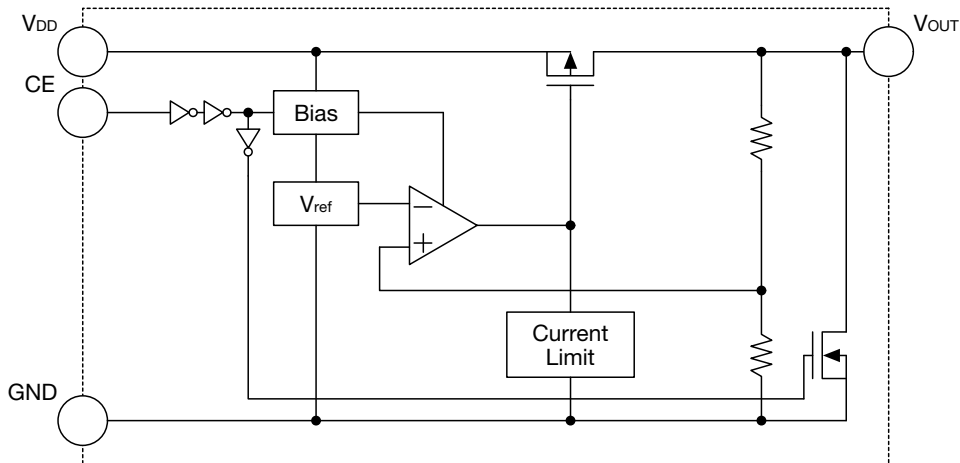

Pin Assignment

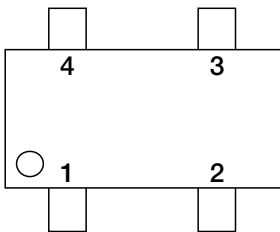

SC-82ABB
(TOP VIEW)

1	CE
2	GND
3	V _{OUT}
4	V _{DD}

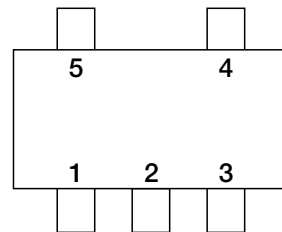

SOT-25A
(TOP VIEW)

1	V _{DD}
2	GND
3	CE
4	NC
5	V _{OUT}

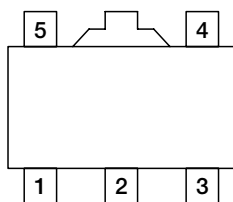

SOT89-5A
(TOP VIEW)

1	V _{OUT}
2	GND
3	NC
4	CE
5	V _{DD}

Note1 : Heat Spreader Bottom with GND.

• Any products mentioned in this catalog are subject to any modification in their appearance and others for improvements without prior notification.
 • The details listed here are not a guarantee of the individual products at the time of ordering. When using the products, you will be asked to check their specifications.

Pin Description

SC-82ABB

Pin No.	Pin name	Functions
1	CE	ON/OFF-Control pin
		CE OUTPUT
		L OFF
		H ON
Connect CE pin with V _{DD} pin, when it is not used.		
2	GND	GND pin
3	V _{OUT}	Output pin
4	V _{DD}	Voltage-Supply pin

SOT-25A

Pin No.	Pin name	Functions
1	V _{DD}	Voltage-supply pin
2	GND	GND pin
3	CE	ON/OFF-Control pin
		CE OUTPUT
		L OFF
		H ON
Connect CE pin with V _{DD} pin, when it is not used.		
4	NC	No connection
5	V _{OUT}	Output pin

SOT89-5A

Pin No.	Pin name	Functions
1	V _{OUT}	Output pin
2	GND	GND pin
3	NC	No connection
4	CE	ON/OFF-Control pin
		CE OUTPUT
		L OFF
		H ON
Connect CE pin with V _{DD} pin, when it is not used.		
5	V _{DD}	Voltage-supply pin

Absolute Maximum Ratings (Except where noted otherwise Ta=25°C)

Item	Symbol	Ratings	Units
Storage Temperature	T _{stg}	-55~+150	°C
Junction Temperature	T _{JMAX}	150	°C
Supply Voltage	V _{DD}	-0.3~+7.0	V
CE input Voltage	V _{CE}	-0.3~+7.0	V
Output Voltage	V _{OUT}	-0.3~+7.0	V
Output Current	I _{omax}	500	mA
Power Dissipation 1	Pd1	330(Note2) (SC-82ABB)	mW
		350(Note3) (SOT-25A)	
		690(Note4) (SOT89-5A)	
Power Dissipation 2	Pd2	650(Note5) (SC-82ABB)	mW
		700(Note5) (SOT-25A)	
		1780(Note5) (SOT89-5A)	

Note2 : With PC Board of glass epoxy 100 × 100 × 1.6mm

Note3 : With PC Board of glass epoxy 60 × 40 × 1.6mm

Note4 : With PC Board of glass epoxy 50 × 50 × 1.6mm

Note5 : JEDEC51-7 standard 114.3 × 76.2 × 1.6mm

Recommended Operating Conditions (Except where noted otherwise Ta=25°C)

Item	Symbol	Ratings	Units
Operating Ambient Temperature	Topr	-40~+85	°C
Operating Voltage	Vop	2.0~6.5	V
Output Current	Iop	0~300	mA

Electrical Characteristics 1 (Except where noted otherwise VDD=VOUT(TYP.)+1V, VCE=VDD, Ta=25°C)

Item	Symbol	Measurement conditions	Min.	Typ.	Max.	Units
Input Current(OFF)	IDDOFF	VCE=0V		0.01	1.0	μA
No-Load Input Current	IDD	IOUT=0mA		25	40	μA
Output Voltage	VOUT	IOUT=10mA (VOUT ≥ 2.0V)	×0.99		×1.01	V
		IOUT=10mA (VOUT ≤ 1.9V)	-0.02		+0.02	V
Line Regulation	VLINE	VOUT (TYP.)+0.5V ≤ VDD ≤ 6.5V VOUT ≥ 1.1V, IOUT=10mA		0.01	0.10	%/V
		VOUT (TYP.)+1.0V ≤ VDD ≤ 6.5V VOUT = 1.0V, IOUT=10mA				
Load Regulation 1 (Note6)	VLOAD1	1mA ≤ IOUT ≤ 150mA		10	40	mV
Load Regulation 2 (Note6)	VLOAD2	1mA ≤ IOUT ≤ 300mA		30	120	mV
Dropout Voltage	ViO	Please refer to another page				V
Ripple Rejection (Note7)	RR	f=1kHz, Vripple=0.5V, IOUT=10mA		70		dB
VOUT Temperature Coefficient (Note7)	ΔVOUT/ΔT	IOUT=10mA, -40 ≤ Top ≤ +85°C		±100		ppm/°C
Output Current Limit	Ilim		300	500		mA
Output Short-Circuit Current (Note7)	Ishort	VOUT=0V		50		mA
CE High Threshold Voltage	VCEH		1.5		VDD	V
CE Low Threshold Voltage	VCEL				0.3	V
CE High Threshold Current	ICEH		-1.0		+1.0	μA
CE Low Threshold Current	ICEL		-1.0		+1.0	μA
CL Discharge Resistance (Note7)	Rdisc	VCE=0V, VDD=6V		10		

Note6 : VDD=2.5V at VOUT ≤ 1.5V.

Note7 : The parameter is guaranteed by design.

Electrical Characteristics 2 (Except where noted otherwise $V_{DD}=V_{OUT}(TYP.)+1V$, $V_{CE}=V_{DD}$, $T_a=25^{\circ}C$)

Model No.	Item							
	Output Voltage				Dropout Voltage			
	V_{OUT} (V)				V_{OUT} (V)			
	Measurement Conditions	Min.	Typ.	Max.	Measurement Conditions	Min.	Typ.	Max.
MM3571A10	$I_{OUT}=10mA$	0.980	1.000	1.020	$I_{OUT}=150mA$ $1.0V \leq V_{OUT} < 1.9V$ (Note8)			
MM3571A11		1.080	1.100	1.120			0.69	0.79
MM3571A12		1.180	1.200	1.220				
MM3571A13		1.280	1.300	1.320				
MM3571A14		1.380	1.400	1.420			0.60	0.70
MM3571A15		1.480	1.500	1.520				
MM3571A16		1.580	1.600	1.620				
MM3571A17		1.680	1.700	1.720			0.51	0.61
MM3571A18		1.780	1.800	1.820				
MM3571A19		1.880	1.900	1.920		$I_{OUT}=150mA$ $1.9V \leq V_{OUT} \leq 5.0V$ $V_{DD}=V_{OUT}(TYP.)-0.2V$		
MM3571A20		1.980	2.000	2.020			0.47	0.57
MM3571A21		2.079	2.100	2.121				
MM3571A22		2.178	2.200	2.222				
MM3571A23		2.277	2.300	2.323				
MM3571A24		2.376	2.400	2.424				
MM3571A25		2.475	2.500	2.525				
MM3571A26		2.574	2.600	2.626				
MM3571A27		2.673	2.700	2.727				
MM3571A28		2.772	2.800	2.828				
MM3571A29		2.871	2.900	2.929		0.31	0.41	
MM3571A30		2.970	3.000	3.030				
MM3571A31		3.069	3.100	3.131				
MM3571A32		3.168	3.200	3.232				
MM3571A33		3.267	3.300	3.333				
MM3571A34		3.366	3.400	3.434				
MM3571A35		3.465	3.500	3.535				
MM3571A36		3.564	3.600	3.636				
MM3571A37		3.663	3.700	3.737				
MM3571A38		3.762	3.800	3.838				
MM3571A39		3.861	3.900	3.939		0.23	0.33	
MM3571A40	3.960	4.000	4.040					
MM3571A41	4.059	4.100	4.141					
MM3571A42	4.158	4.200	4.242					
MM3571A43	4.257	4.300	4.343					
MM3571A44	4.356	4.400	4.444					
MM3571A45	4.455	4.500	4.545					
MM3571A46	4.554	4.600	4.646					
MM3571A47	4.653	4.700	4.747					
MM3571A48	4.752	4.800	4.848		0.19	0.28		
MM3571A49	4.851	4.900	4.949					
MM3571A50	4.950	5.000	5.050					

Note8 : Dropout voltage maximum value in the input and it is confirmed that there is no output abnormal voltage impression the 150mA in the model less than $V_{OUT} < 1.9V$.

• Any products mentioned in this catalog are subject to any modification in their appearance and others for improvements without prior notification.
 • The details listed here are not a guarantee of the individual products at the time of ordering. When using the products, you will be asked to check their specifications.

Measuring Circuit

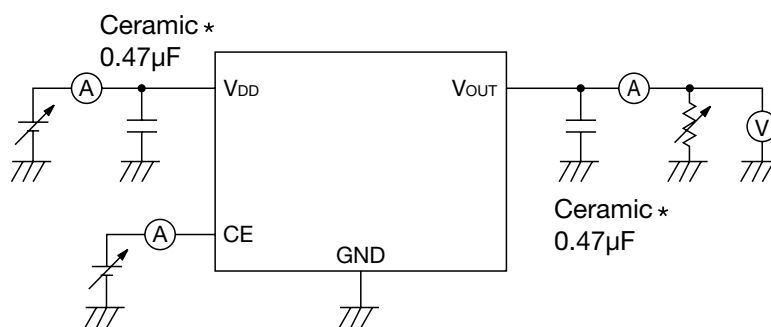

Application Circuit

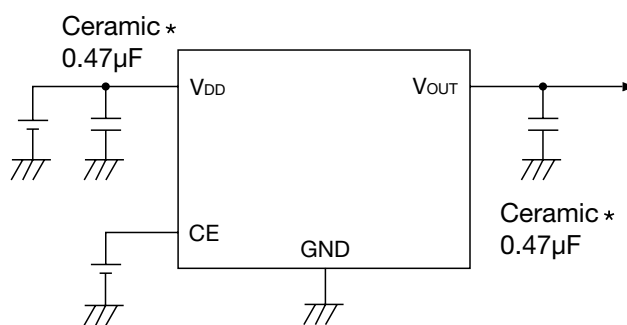

* Temperature Characteristics : B

(Reference example of external parts)

- Output capacitor Ceramic capacitor 0.47µF
- Input capacitor Ceramic capacitor 0.47µF

- We shall not be liable for any trouble or damage caused by using this circuit.
- In the event a problem which may affect industrial property or any other rights of us or a third party is encountered during the use of information described in these circuit, we shall not be liable for any such problem, nor grant a license therefore.

· Note

1. Please use this IC within the stated absolute maximum ratings.
The IC is liable to malfunction should the ratings be exceeded.
2. Due to restrictions on the package power dissipation, the output current value may not be satisfied.
Attention should be paid to the power dissipation of the package when the output current is large or the voltage between Input and Output is high.
3. The output capacitor is required between output and GND to prevent oscillation.
4. The ESR of capacitor must be defined in ESR stability area. It is possible to use a ceramic capacitor without ESR resistance for output. The ceramic capacitor must be used more than 0.47 μ F and B temperature characteristics.
5. The wire of VDD and GND is required to print full ground plane for noise and stability.
6. The input capacitor must be connected a distance of less than 1cm from input pin.
7. It is able to oscillation when you use the capacitor with intense capacitance change such as micro.
Please evaluate IC in the set.
8. In case the output voltage is above the input voltage, the overcurrent flow by internal parastic diode from output to input. In such application, the external bypass diode must be connected between output and input pin.
9. This IC will limit the output current with the overcurrent protection circuit when the overcurrent and the output do short-circuit.
However, IC generates heat because of the substrate and use conditions and there is a possibility of destroying it exceeding a permissible loss.
The characteristic changes depending on the substrate condition. Please evaluate IC in the set.

About Power Dissipation

The Power dissipation change if board to mount IC change because radiative heat fix at board. It is reference data below, Evaluate IC in the set.

MM3571AxxURE

1. PC Board of glass epoxy

Board size 100mm×100mm t=1.6mm Copper foil area 10%
 Power dissipation 330mW Ta=25°C

2. JEDEC51-7 standard

Board size 114.3mm×76.2mm t=1.6mm Copper foil area 80%
 Power dissipation 650mW Ta=25°C (It is reference value measured by JEDEC51-7 standard.)

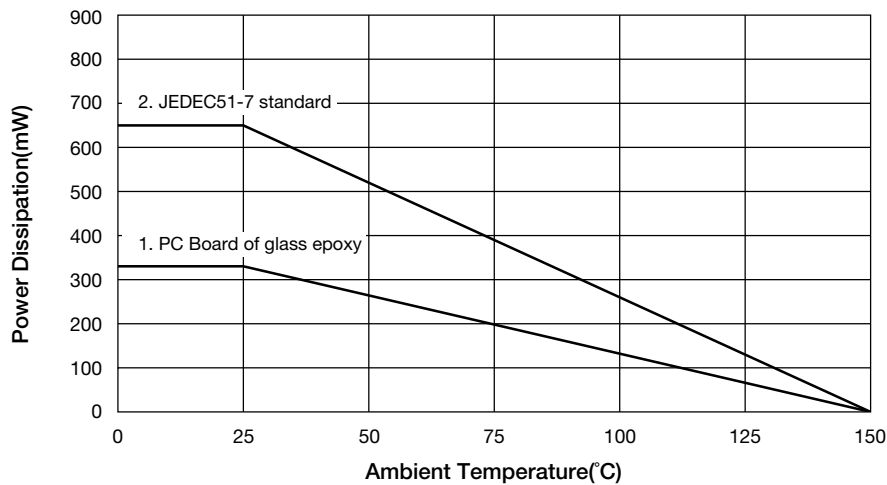

MM3571AxxNRE

1. PC Board of glass epoxy

Board size 60mm×40mm t=1.6mm Copper foil area 60%
 Power dissipation 350mW Ta=25°C

2. JEDEC51-7 standard

Board size 114.3mm×76.2mm t=1.6mm Copper foil area 80%
 Power dissipation 700mW Ta=25°C (It is reference value measured by JEDEC51-7 standard.)

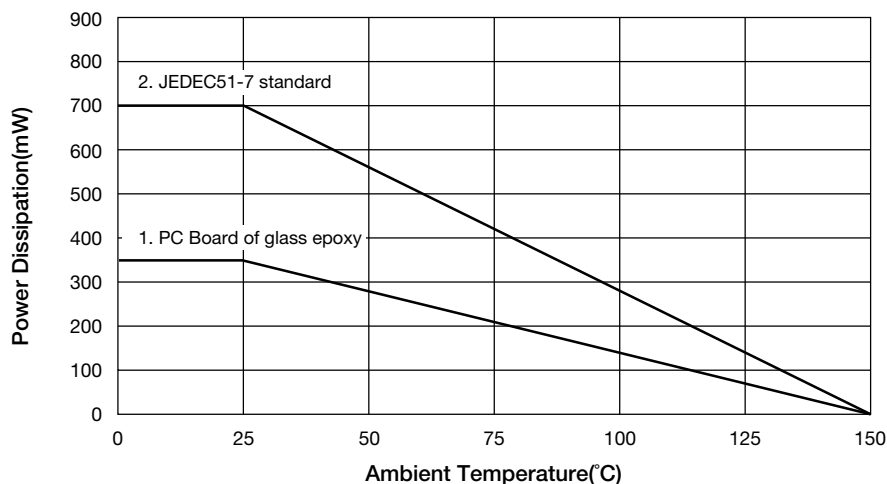

• Any products mentioned in this catalog are subject to any modification in their appearance and others for improvements without prior notification.
 • The details listed here are not a guarantee of the individual products at the time of ordering. When using the products, you will be asked to check their specifications.

MM3571AxxPRE

1. PC Board of glass epoxy

Board size 50mm×50mm t=1.6mm Copper foil area 20%

Power dissipation 690mW Ta=25°C

2. JEDEC51-7 standard

Board size 114.3mm×76.2mm t=1.6mm Copper foil area 80%

Power dissipation 1780mW Ta=25°C (It is reference value measured by JEDEC51-7 standard.)

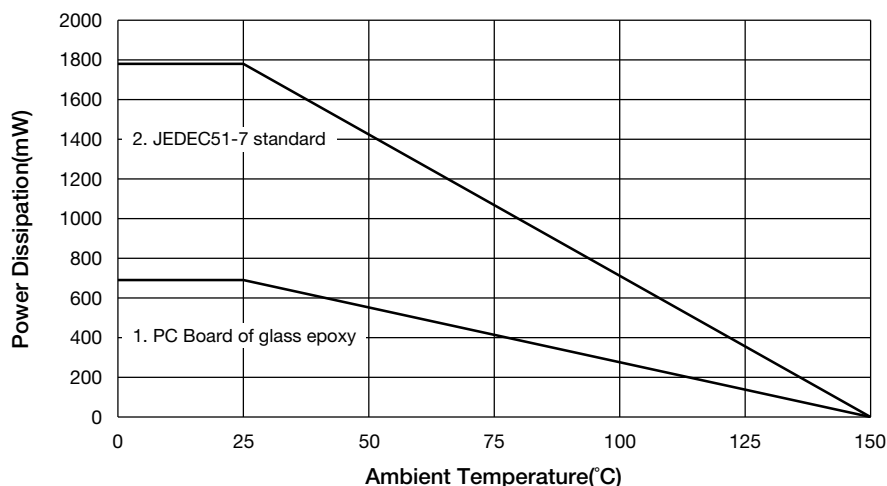

It is recommended to layout the VIA for heat radiation in the GND pattern of reverse (of IC) when there is the GND pattern in the inner layer (in using multi-layer substrate).

By increasing these copper foil pattern area of PCB, Power dissipation improves.

Characteristics (V_{OUT}=1.0V) (Except where noted otherwise V_{DD}=V_{OUT}(TYP.)+1V, V_{CE}=V_{DD}, Ta=25°C)

Input Voltage - Output Voltage

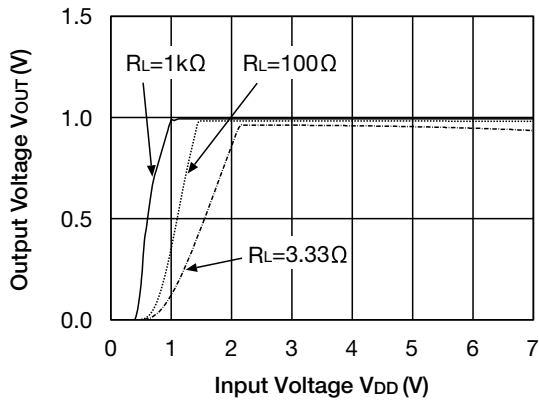

Input Voltage - Input Current

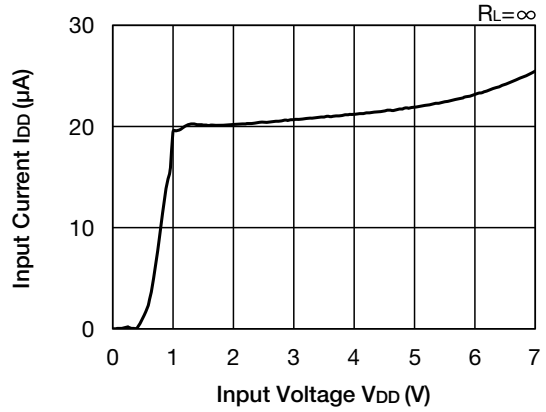

Load Regulation

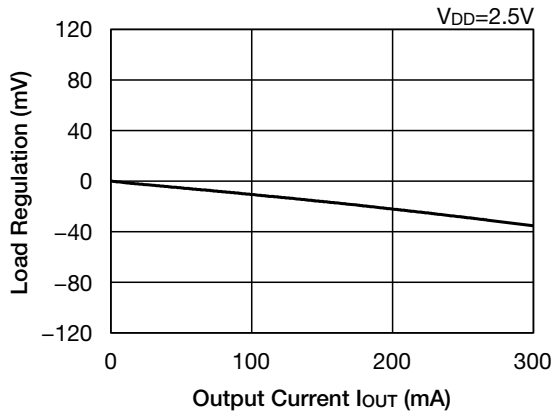

Line Regulation

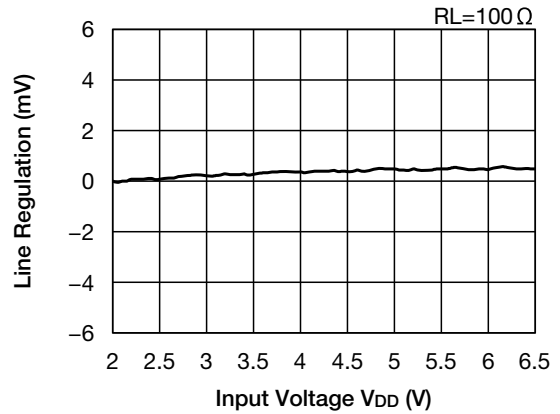

V_{out} Temperature Coefficient

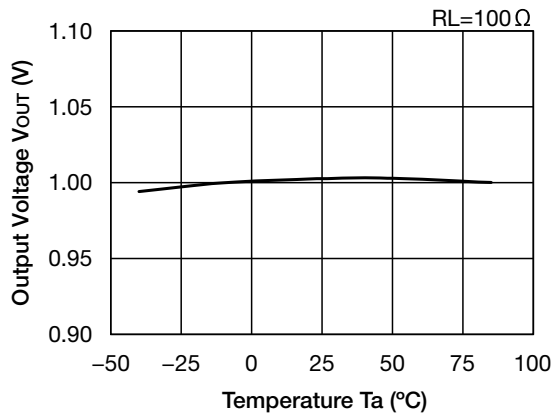

• Any products mentioned in this catalog are subject to any modification in their appearance and others for improvements without prior notification.
 • The details listed here are not a guarantee of the individual products at the time of ordering. When using the products, you will be asked to check their specifications.

Ripple Rejection

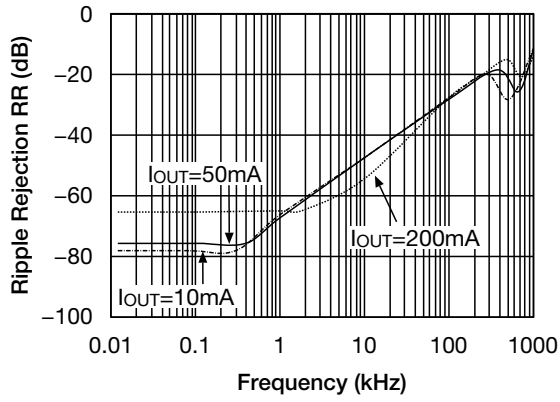

ESR stable area

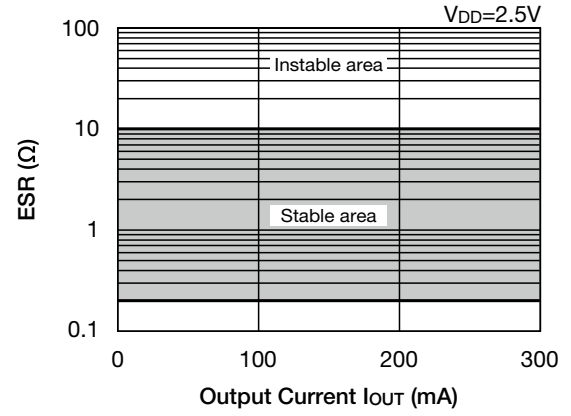

Current Limit

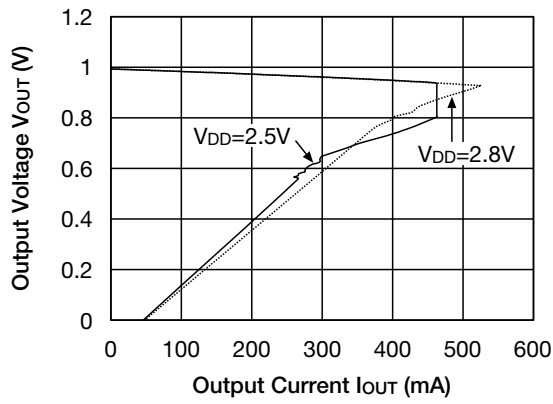

Load Transient response
 ($V_{DD}=2.5V$, $V_{CE}=V_{DD}$, $C_{in}=C_{out}=0.47\mu F$)

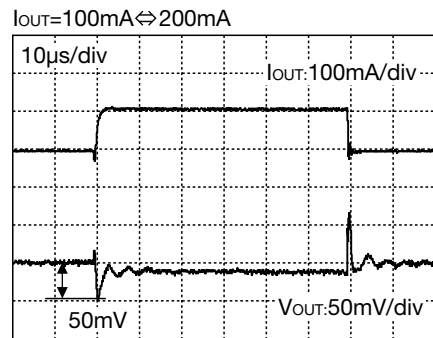
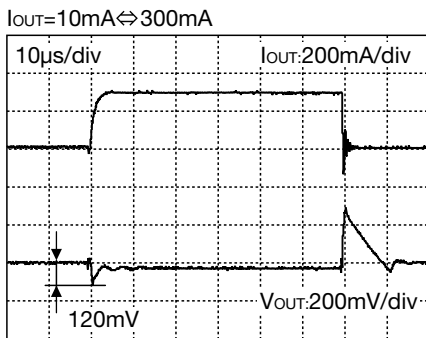
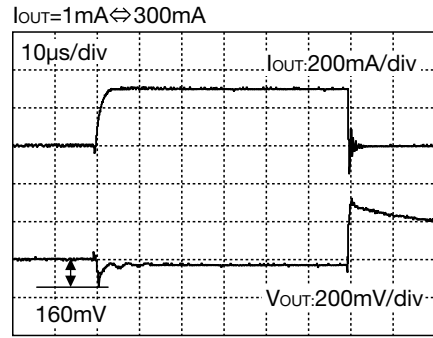
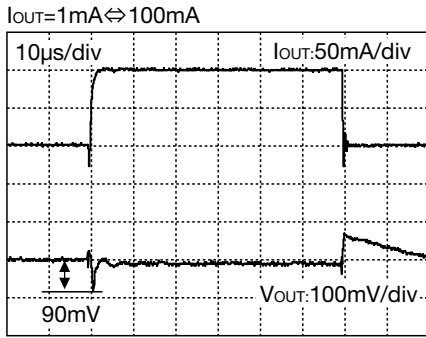

CE Transient
 ($V_{DD}=2.5V$, $V_{CE}=0V \rightarrow V_{DD}$, $C_O=0.47\mu F$)

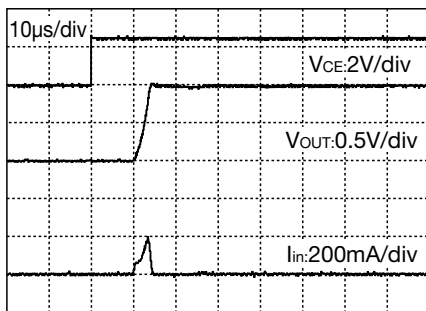

CE Transient
 ($V_{DD}=2.5V$, $V_{CE}=0V \rightarrow V_{DD}$, $C_O=10\mu F$)

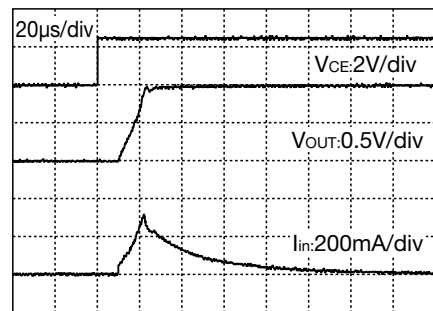

Output Rise Time

($V_{DD}=2.5V$, $V_{CE}=0V \rightarrow V_{DD}$, $C_{in}=0.47\mu F$)

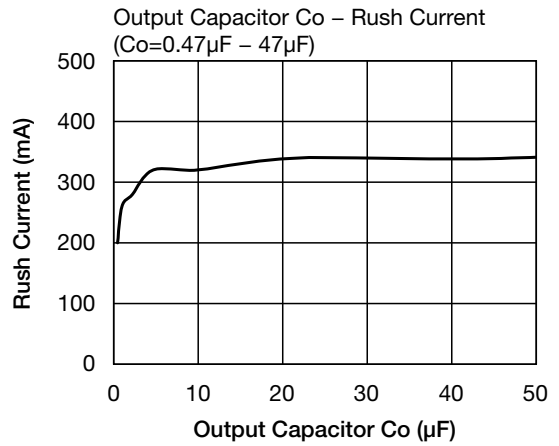
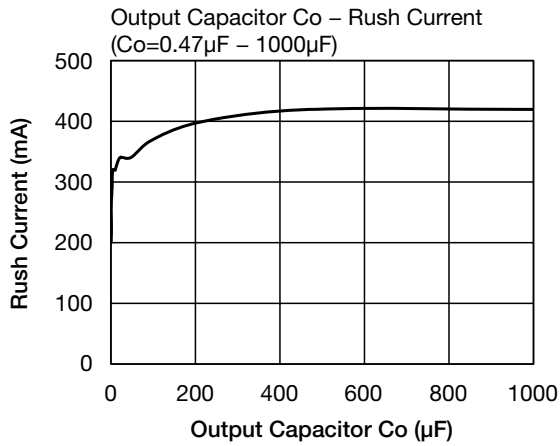
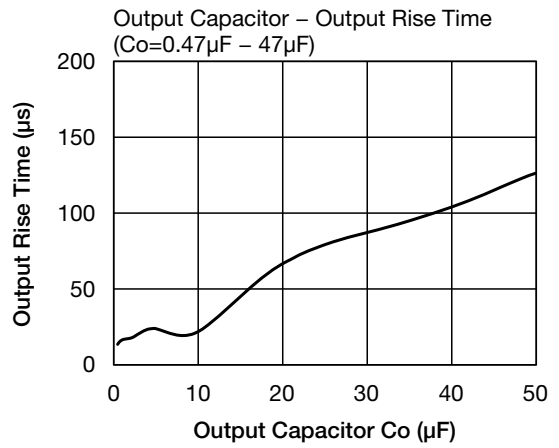
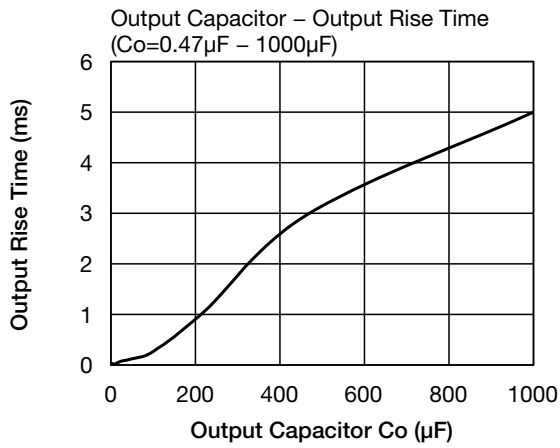

Characteristics (V_{OUT}=3.0V) (Except where noted otherwise V_{DD}=V_{OUT}(TYP.)+1V, V_{CE}=V_{DD}, Ta=25°C)

Input Voltage - Output Voltage

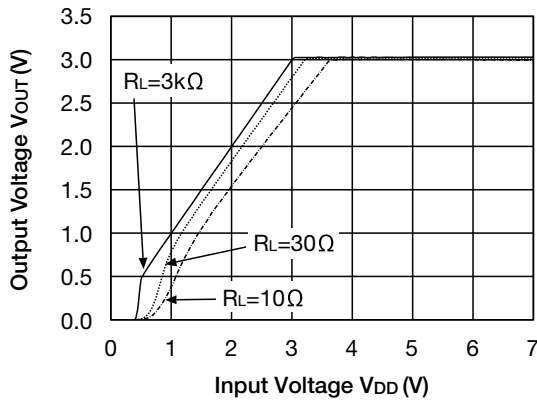

Input Voltage - Input Current

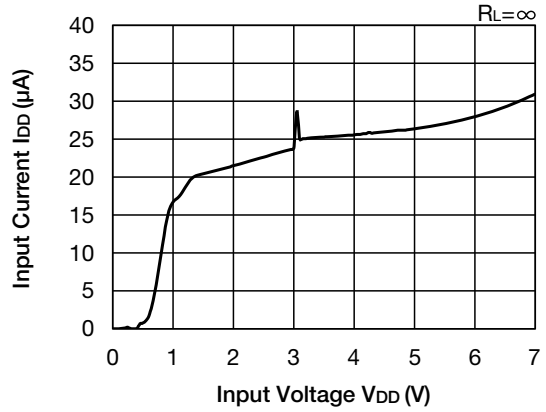

Load Regulation

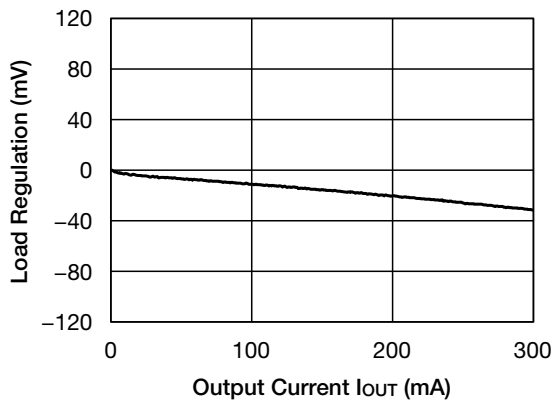

Line Regulation

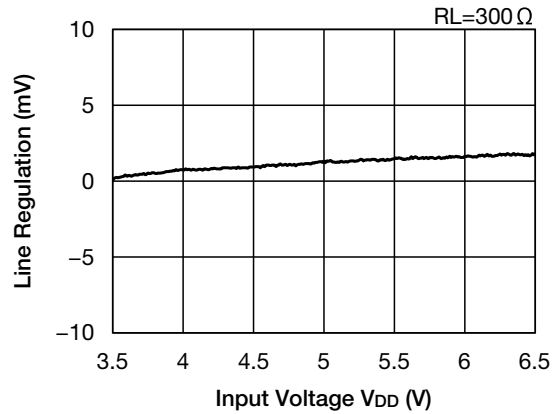

Dropout Voltage

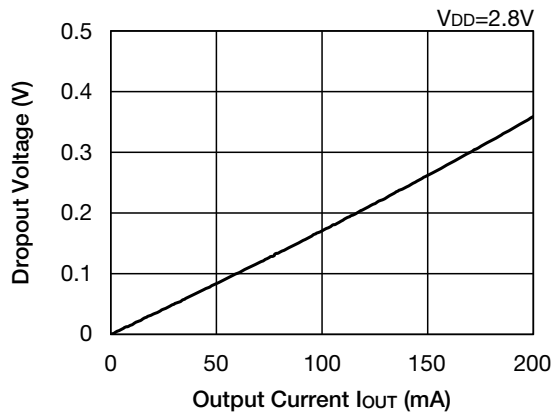

Vout Temperature Coefficient

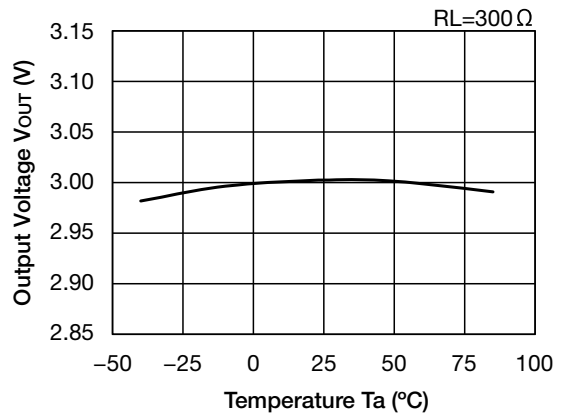

• Any products mentioned in this catalog are subject to any modification in their appearance and others for improvements without prior notification.
 • The details listed here are not a guarantee of the individual products at the time of ordering. When using the products, you will be asked to check their specifications.

Ripple Rejection

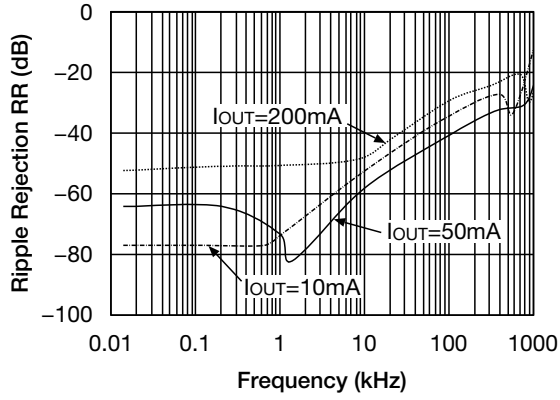

ESR stable area

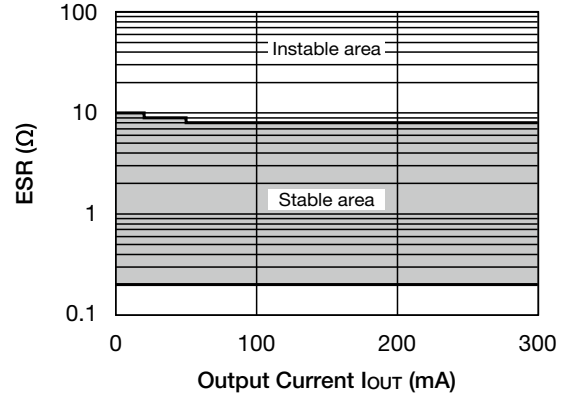

Current Limit

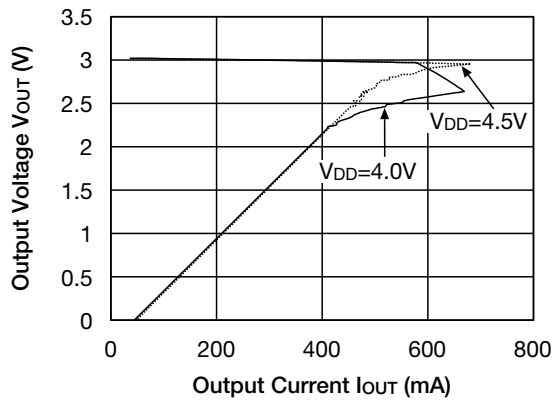

Load Transient response
 ($V_{DD}=V_{OUT}+1V$, $V_{CE}=V_{DD}$, $C_{in}=C_{out}=0.47\mu F$)

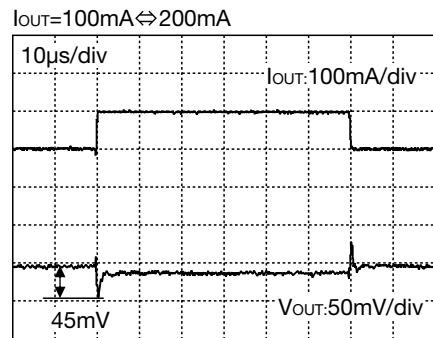
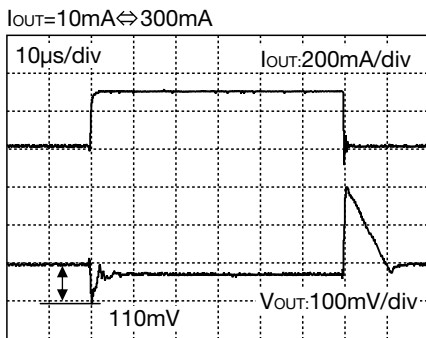
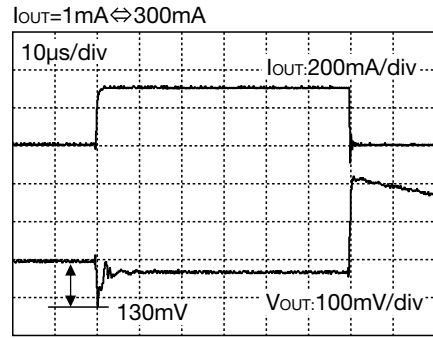
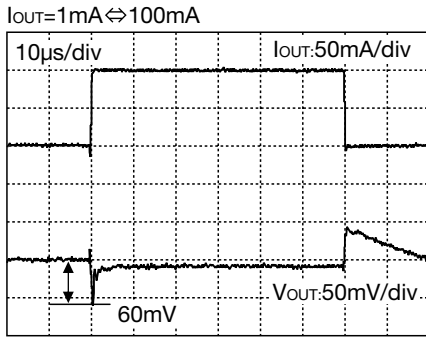

CE Transient
 ($V_{DD}=V_{OUT}+1V$, $V_{CE}=0V \rightarrow V_{DD}$, $C_o=0.47\mu F$)

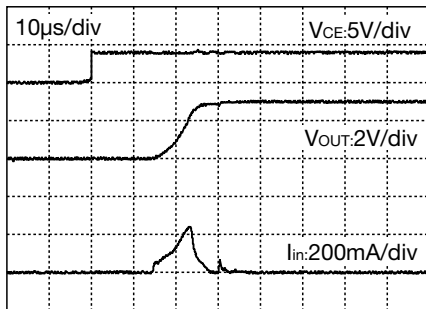

CE Transient
 ($V_{DD}=V_{OUT}+1V$, $V_{CE}=0V \rightarrow V_{DD}$, $C_o=10\mu F$)

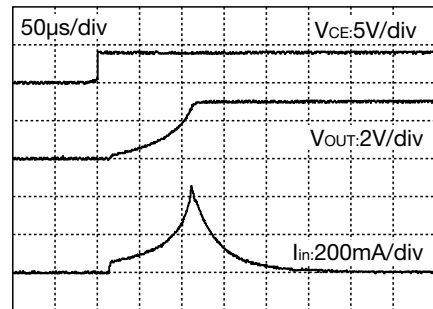

Output Rise Time
 ($V_{DD}=V_{OUT}+1V$, $V_{CE}=0V \rightarrow V_{DD}$, $C_{in}=0.47\mu F$)

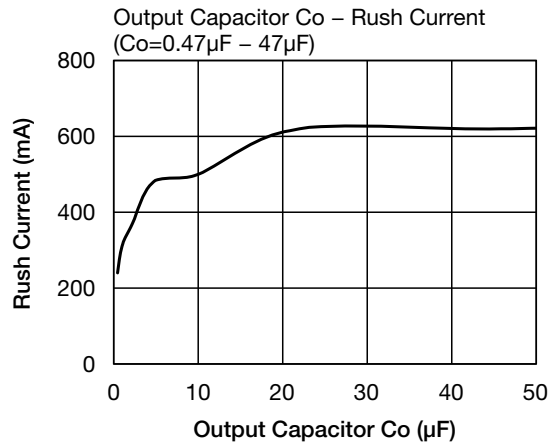
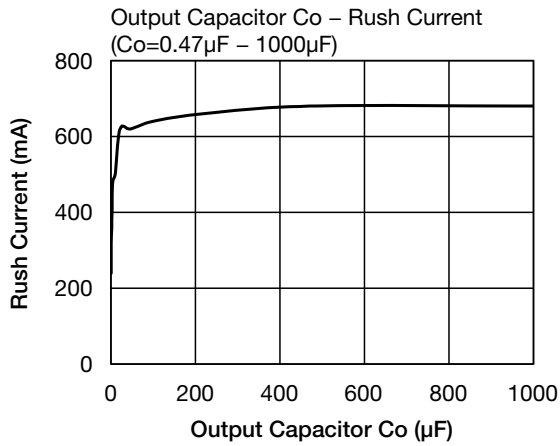
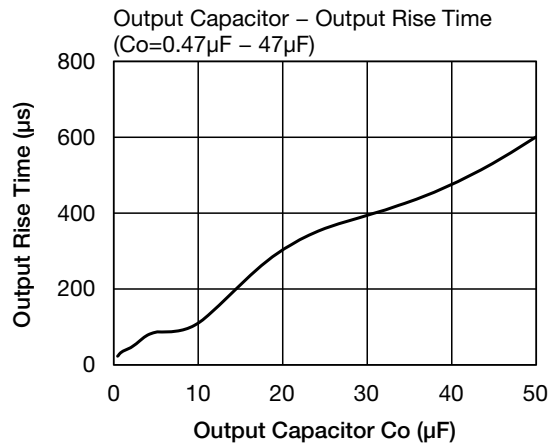
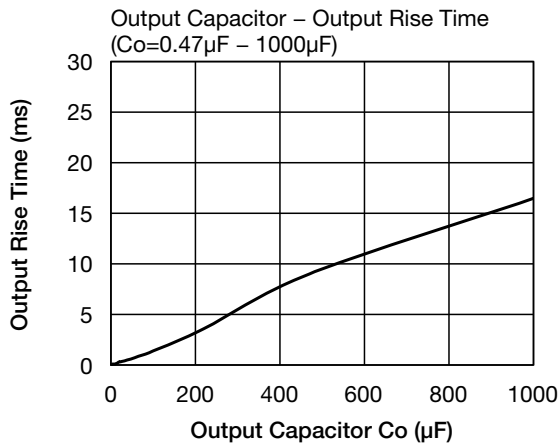

Characteristics (V_{OUT}=5.0V) (Except where noted otherwise V_{DD}=V_{OUT}(TYP.)+1V, V_{CE}=V_{DD}, Ta=25°C)

Input Voltage - Output Voltage

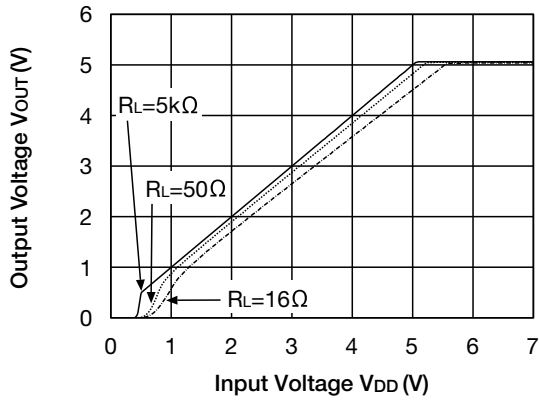

Input Voltage - Input Current

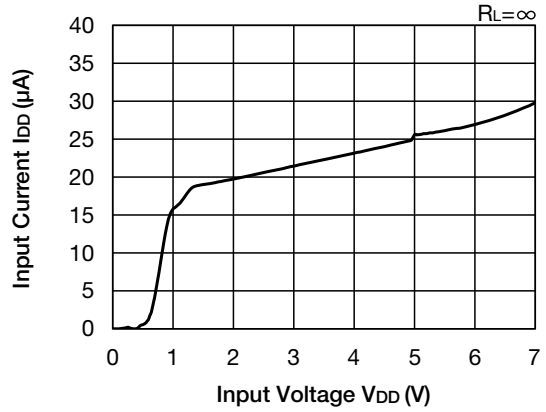

Load Regulation

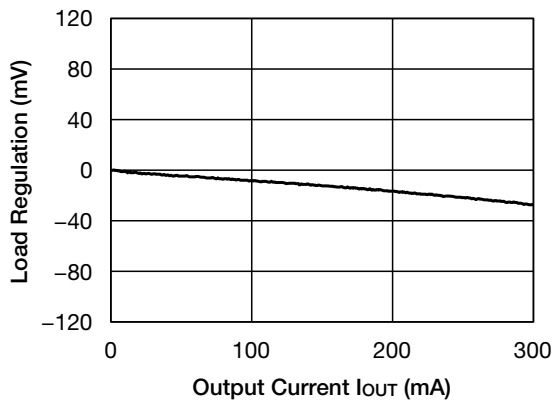

Line Regulation

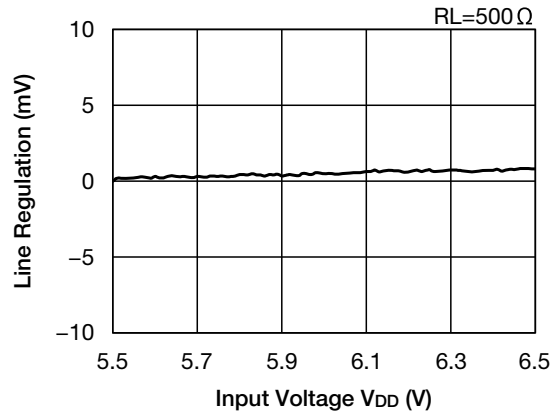

Dropout Voltage

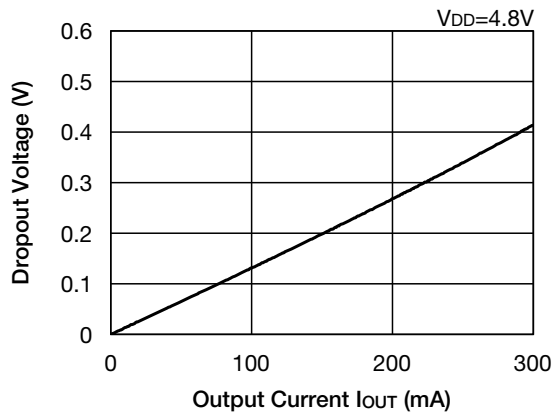

Vout Temperature Coefficient

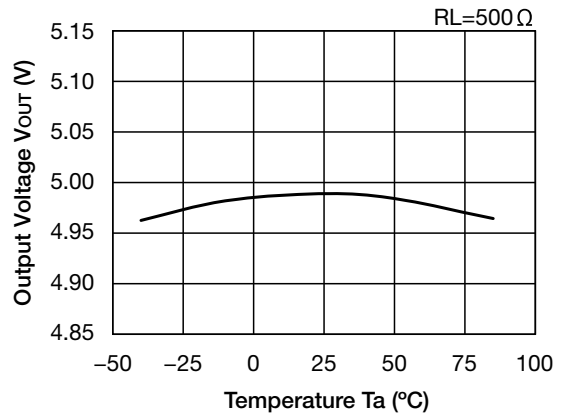

Ripple Rejection

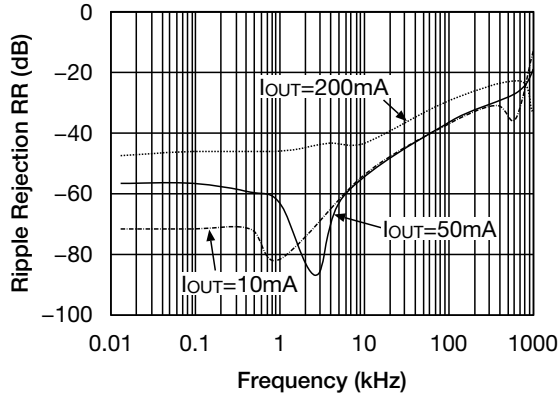

ESR stable area

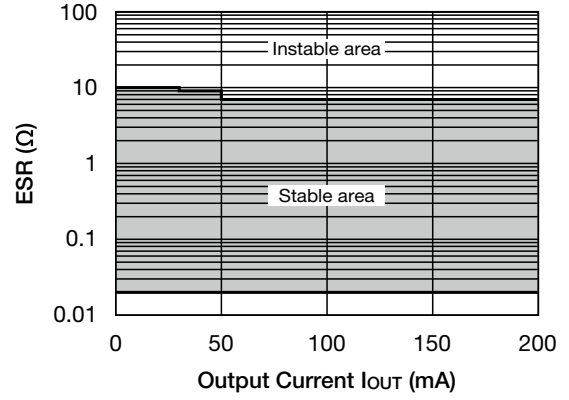

Current Limit

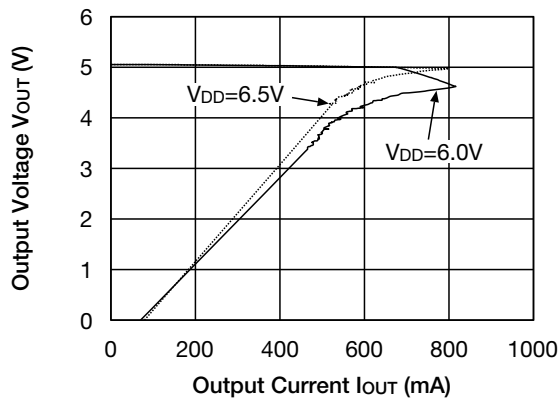

Load Transient response
 ($V_{DD}=V_{OUT}+1V$, $V_{CE}=V_{DD}$, $C_{in}=C_{out}=0.47\mu F$)

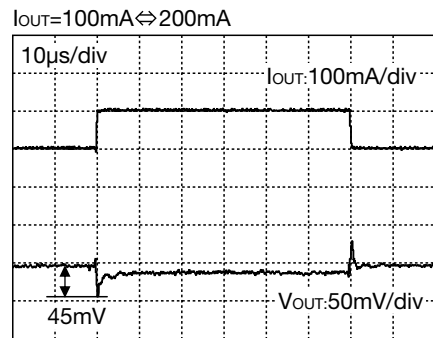
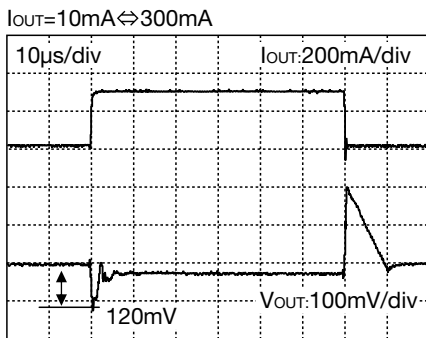
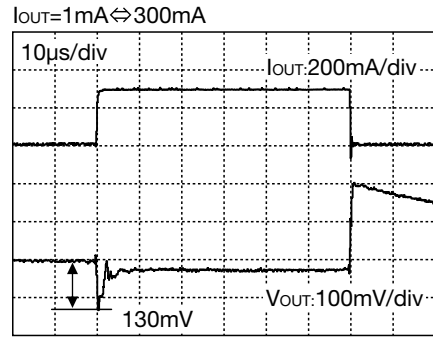
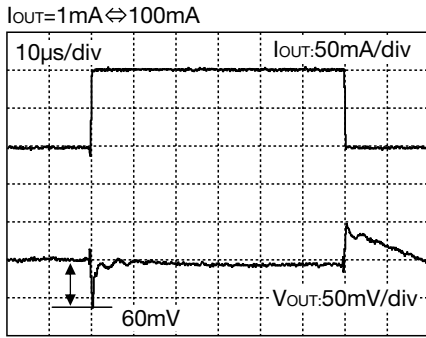

CE Transient
 ($V_{DD}=V_{OUT}+1V$, $V_{CE}=0V \rightarrow V_{DD}$, $C_o=0.47\mu F$)

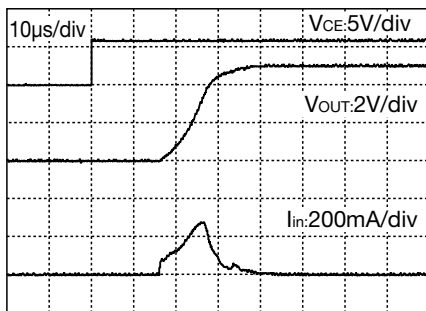

CE Transient
 ($V_{DD}=V_{OUT}+1V$, $V_{CE}=0V \rightarrow V_{DD}$, $C_o=10\mu F$)

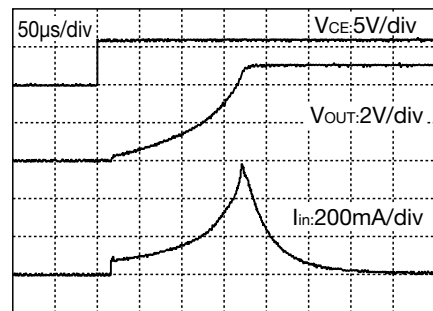

Output Rise Time

($V_{DD}=V_{OUT}+1V$, $V_{CE}=0V \rightarrow V_{DD}$, $C_{in}=0.47\mu F$)

