

# Low noise 300mA LDO

## Monolithic IC MM1899 Series

### Outline

This IC is a low noise 300mA LDO by bipolar process. The applications by new noise reduction circuit are for a power supply of highly sensitive CMOS image sensor.  
It is small space by SOT-25 or small package SSON-6A.

### Features

1. Maximum supply voltage	15V
2. Operating input voltage	14V
3. No load input current	140 $\mu$ A typ.
4. Shutdown current	6 $\mu$ A typ.
5. Output voltage range	1.5 to 5.4V
6. Output voltage accuracy	$\pm$ 1%
7. Dropout voltage	0.35V typ. (I <sub>o</sub> =300mA)
8. Line regulation	0.1%/V max.
9. Load regulation	60mV max. (I <sub>o</sub> =1 to 300mA)
10. V <sub>out</sub> temperature coefficient	$\pm$ 100ppm/ $^{\circ}$ C typ.
11. Ripple rejection	70dB typ. (f=1kHz)
12. Output noise voltage	30 $\mu$ V <sub>rms</sub> typ. (f=10 to 100kHz)
13. ON/OFF control pin	
14. Thermal shut down	
15. Output discharge function	
16. Output capacitor	1 $\mu$ F

### Package

SOT-25  
SSON-6A

### Applications

1. Image sensor
2. Sensor power supply
3. Analog power supply

Block Diagram

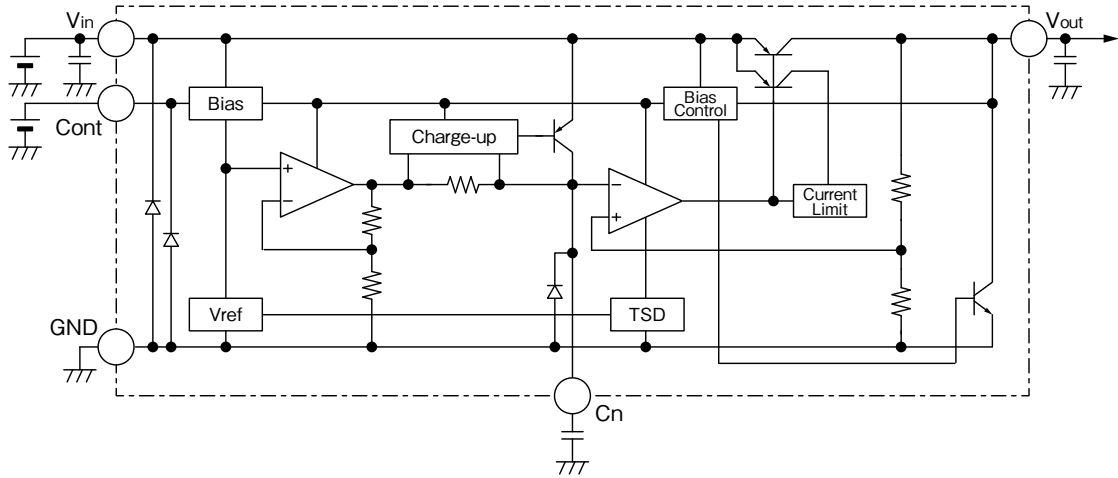

Pin Assignment

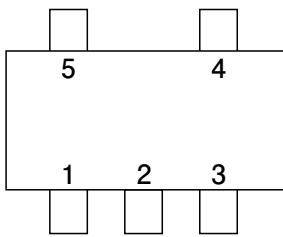

SOT-25A  
(TOP VIEW)

1	Vin
2	GND
3	Cont
4	Cn
5	Vout

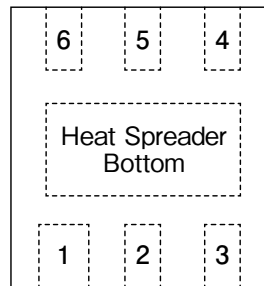

SSON-6A  
(TOP VIEW)

1	Vin
2	NC
3	Vout
4	Cn
5	GND
6	Cont

## Pin Description

### SOT-25A

Pin No.	Pin name	Functions
1	Vin	Supply voltage pin
2	GND	GND pin
3	Cont	Control pin Vcont=H : Output ON Vcont=L : Output OFF
4	Cn	Reducing noise pin with capacitor The pin voltage is changed by the output voltage rank.
5	Vout	Output voltage output pin

### SSON-6A

Pin No.	Pin name	Functions
1	Vin	Supply voltage pin
2	NC	No connection
3	Vout	Output voltage output pin
4	Cn	Reducing noise pin with capacitor The pin voltage is changed by the output voltage rank.
5	GND	GND pin
6	Cont	Control pin Vcont=H : Output ON Vcont=L : Output OFF

## Absolute Maximum Ratings (Except where noted otherwise Ta=25°C)

Item	Symbol	Ratings	Units	
Supply voltage	Vin	-0.3 to +15	V	
V- terminal input voltage	Vcont	-0.3 to +15		
COUT terminal Output voltage	Iout	0 to 400	mA	
Junction Temperature	TjMAX	125	°C	
Storage Temperature	Tstg	-55 to +125		
Power Dissipation	Pd	SOT-25A	560 (Note1)	mW
		SSON-6A	1000 (Note1)	

Note1 : JEDEC51-7 Standard 114.3mm×76.2mm, t=1.6mm

## Recommended Operating Conditions (Except where noted otherwise Ta=25°C)

Item	Symbol	Ratings	Units
Operating Ambient temperature	Topr	-40 to +85	°C
Operating Voltage	Vop	2 to 14	V
Output Current	Iop	0 to 300	mA

**Electrical Characteristics 1** (Except where noted otherwise  $V_{in}=V_{out}$  (Typ.) +1V,  $I_{out}=1mA$ ,  $V_{cont}=1.4V$ ,  $T_a=25^{\circ}C$ )

Item	Symbol	Measurement conditions	Min.	Typ.	Max.	Units
Input current consumption (OFF)	$I_{in\_OFF}$	$V_{in}=6.0V$ , $V_{cont}=0V$ Include discharge circuit		6	12	$\mu A$
No-Load input current consumption	$I_{in}$			140	220	
Output voltage	$V_{out}$	$I_{out}=1mA$	$\times 0.99$		$\times 1.01$	V
Dropout voltage	$V_{io}$	$V_{in}=V_{out}-0.2V$ , $I_{out}=300mA$		0.35	0.50	
Line regulation	$\Delta V_{line}$	$V_{in}=V_{out}+1V$ to 14V, $I_{out}=1mA$		0.01	0.10	%/V
Load regulation	$\Delta V_{load}$	$I_{out}=1m$ to 300mA		10	60	mV
$V_{out}$ temperature coefficient (Note2)	$\Delta V_{out} / \Delta T$	$T_a=-40$ to $+85^{\circ}C$		$\pm 100$		ppm/ $^{\circ}C$
Ripple rejection (Note2)	RR	$f=1kHz$ , $V_{ripple}=1V$ , $V_{out}=3.0V$ , $I_{out}=10mA$ , $C_n=0.01\mu A$		70		dB
Output noise voltage (Note2)	$V_{outn}$	$fBW=10k$ to 100kHz, $V_{out}=3V$ , $I_{out}=10mA$ , $C_n=0.01\mu A$		30		$\mu V_{rms}$
Cont pin input current	$I_{cont}$	$V_{cont}=1.4V$		4	7	$\mu A$
Cont pin High Threshold level	$V_{contH}$	$V_{out}$ : ON	1.4			V
Cont pin Low Threshold level	$V_{contL}$	$V_{out}$ : OFF			0.4	
Output discharge current	$I_{dis}$	$V_{in}=6.0V$ , $V_{cont}=0V$	100	180		mA

Note2 : The parameter is guaranteed by design.

**Electrical Characteristics 2** (Except where noted otherwise  $V_{in}=V_{out}(\text{Typ.})+1\text{V}$ ,  $I_{out}=1\text{mA}$ ,  $V_{cont}=1.4\text{V}$ ,  $T_a=25^\circ\text{C}$ )

Output voltage	Measurement Conditions	Output Voltage (V)		
		Min.	Typ.	Max.
1.5	$I_{out}=1\text{mA}$	1.485	1.500	1.515
1.6		1.584	1.600	1.616
1.7		1.683	1.700	1.717
1.8		1.782	1.800	1.818
1.9		1.881	1.900	1.919
2.0		1.980	2.000	2.020
2.1		2.079	2.100	2.121
2.2		2.178	2.200	2.222
2.3		2.277	2.300	2.323
2.4		2.376	2.400	2.424
2.5		2.475	2.500	2.525
2.6		2.574	2.600	2.626
2.7		2.673	2.700	2.727
2.8		2.772	2.800	2.828
2.9		2.871	2.900	2.929
3.0		2.970	3.000	3.030
3.1		3.069	3.100	3.131
3.2		3.168	3.200	3.232
3.3		3.267	3.300	3.333
3.4		3.366	3.400	3.434
3.5		3.465	3.500	3.535
3.6		3.564	3.600	3.636
3.7		3.663	3.700	3.737
3.8		3.762	3.800	3.838
3.9		3.861	3.900	3.939
4.0		3.960	4.000	4.040
4.1		4.059	4.100	4.141
4.2		4.158	4.200	4.242
4.3	4.257	4.300	4.343	
4.4	4.356	4.400	4.444	
4.5	4.455	4.500	4.545	
4.6	4.554	4.600	4.646	
4.7	4.653	4.700	4.747	
4.8	4.752	4.800	4.848	
4.9	4.851	4.900	4.949	
5.0	4.950	5.000	5.050	
5.1	5.049	5.100	5.151	
5.2	5.148	5.200	5.252	
5.3	5.247	5.300	5.353	
5.4	5.346	5.400	5.454	

• Any products mentioned in this catalog are subject to any modification in their appearance and others for improvements without prior notification.  
 • The details listed here are not a guarantee of the individual products at the time of ordering. When using the products, you will be asked to check their specifications.

Measuring Circuit

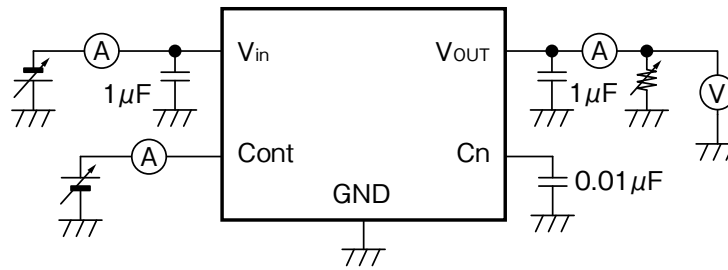

Application Circuit

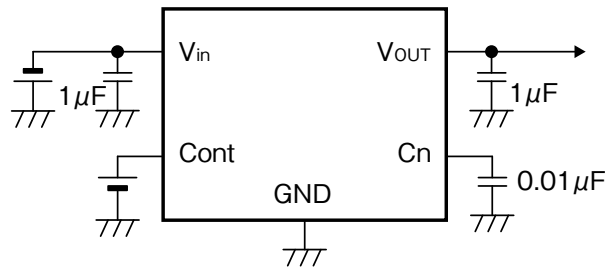

\* Temperature Characteristics : B

(Reference example of external parts)

- Output capacitor                      Ceramic capacitor 1.0µF
- Input capacitor                        Ceramic capacitor 1.0µF
- Cn capacitor                            Ceramic capacitor 0.01µF

· In the event a problem which may affect industrial property or any other rights of us or a third party is encountered during the use of information described in these circuit, we shall not be liable for any such problem, nor grant a license therefore.

NOTE

1. There is a possibility with deterioration and destruction of IC when using it exceeding the absolute maximum rating. The absolute maximum rating, Never exceed it.  
The functional operation is not assured.
2. There is a possibility that it becomes impossible to maintain this performance and reliability IC original when using it exceeding recommended operation voltage.  
Please use it in recommended operation voltage.
3. Due to restrictions on the package power dissipation, the output current value may not be satisfied.  
Attention should be paid to the power dissipation of the package when the output current is large or the voltage between Input and Output is high.
4. The output capacitor is required between output and GND to prevent oscillation.
5. The ESR of capacitor must be defined in ESR stability area.  
It is possible to use a ceramic capacitor without ESR resistance for output.  
The ceramic capacitor must be used more than 1.0 $\mu$ F and B temperature characteristics.
6. The wire of Vin and GND is required to print full ground plane for noise and stability.
7. The input capacitor must be connected a distance of less than 1 cm from input pin.
8. In case the output voltage is above the input voltage, the overcurrent flow by internal parasitic diode from output to input.  
In such application, the external bypass diode must be connected between output and input pin.

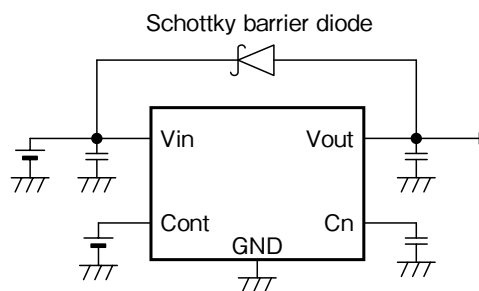

9. It is able to an unstable operation when you use the capacitor with intense capacitance change.  
The capacitor has the dependency at the power-supply voltage and the temperature.  
The capacity value changes by the environment used. Please evaluate IC in the set.
10. The IC has the thermal shutdown protection.
11. This IC will limit the output current with the overcurrent protection circuit when the overcurrent and the output do short-circuit. However, IC generates heat because of the substrate and use conditions and there is a possibility of destroying it exceeding a permissible loss.  
The characteristic changes depending on the substrate condition.  
Please evaluate IC in the set.
12. The IC has the pull-down resistance of the Cont terminal.
13. The overshoot might be generated in start up for hight output voltage rank.  
The overshoot might be generated by ambient temperature and load condition.  
Please evaluate IC in the set.

14. It is no data in under 0.02Ω of ESR characteristics. (dotted line area)  
 Don't be measured in this area because ceramic capacitor contain 0.02Ω in parts self.  
 Ceramic capacitor only can be used without ESR resistance parts.  
 Please evaluate IC in the set if the capacitor that is low resistance used.

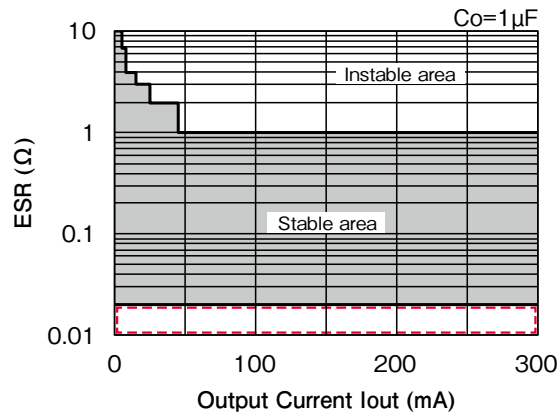

15. Discharge current depend on power supply Vin and output voltage Vout.  
 Reference to Below current characteristics.

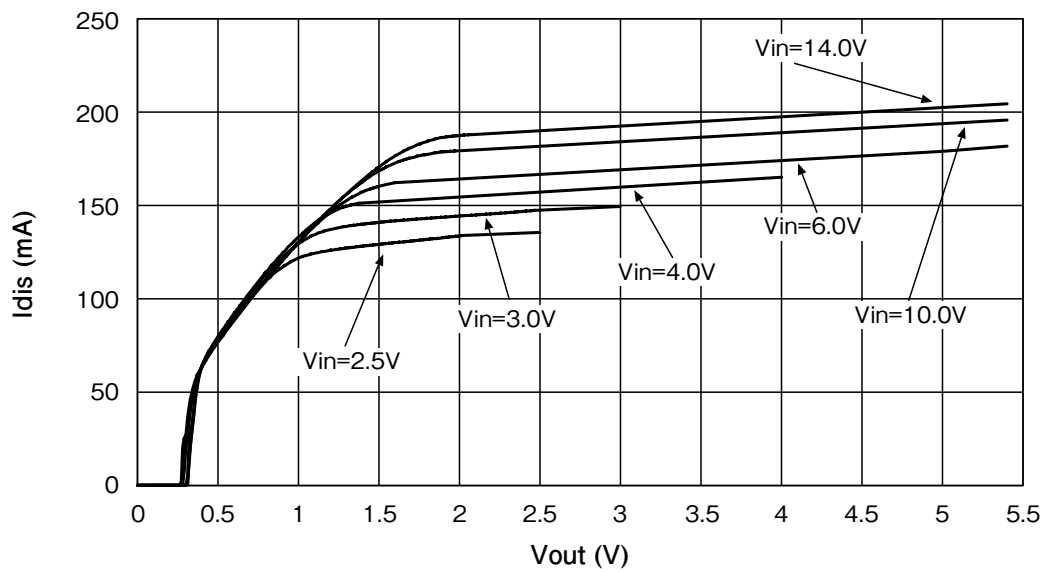



## About Power Dissipation

The Power dissipation change if board to mount IC change because radiative heat fix at board. It is reference data below, Evaluate IC in the set.

### SOT-25A

1. JEDEC51-7 standard

Board size 114.3mm×76.2mm t=1.6mm Copper foil area 80%

Power dissipation

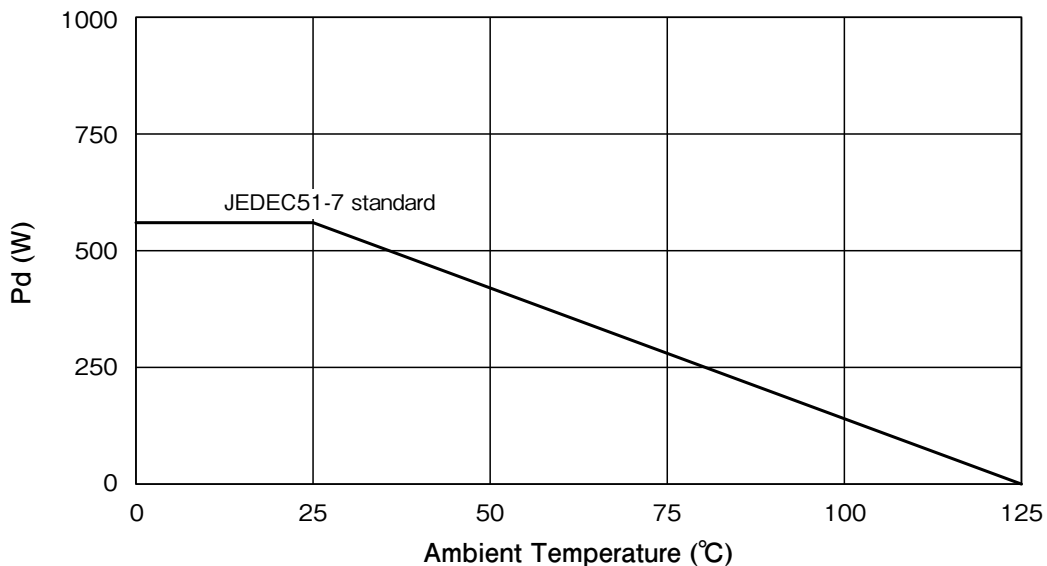

### SSON-6A

1. JEDEC51-7 standard

Board size 114.3mm×76.2mm t=1.6mm Copper foil area 80%

Power dissipation 1000mW Ta=25°C (It is reference value measured by JEDEC51-7 standard.)

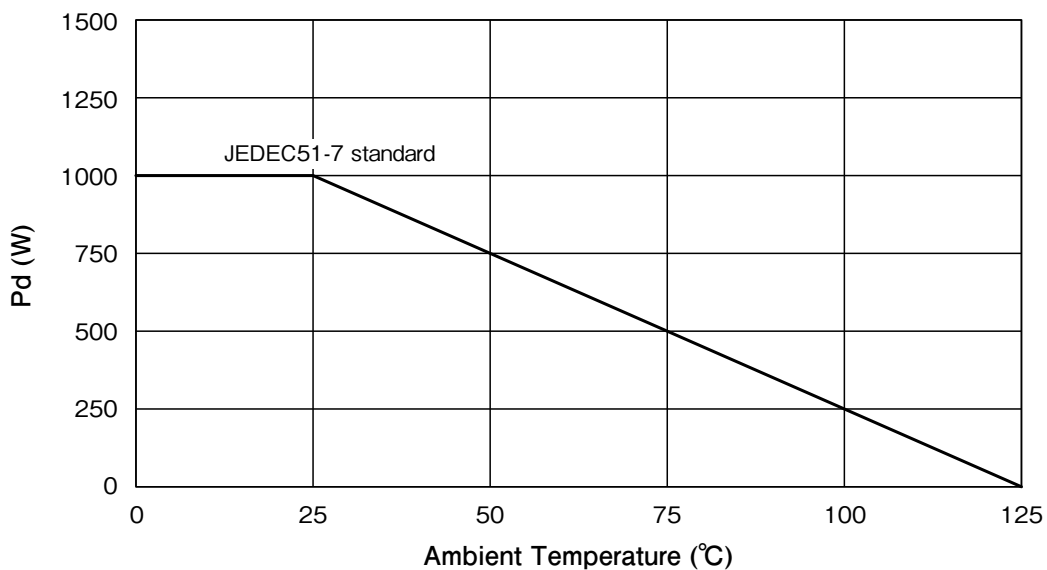

It is recommended to layout the VIA for heat radiation in the GND pattern of reverse (of IC) when there is the GND pattern in the inner layer (in using multi-layer substrate).

By increasing these copper foil pattern area of PCB, Power dissipation improves.

Considering a products life on reliability, it is recommended to design with a sufficient margin for the power dissipation.

**Characteristics (Vo=1.5V)** (Except where noted otherwise Vin=Vo+1V, Vcont=1.4V, Cin=1μF, Co=1μF, Cn=0.01μF, Ta=25°C)

**Input Current (OFF) - Input Voltage**

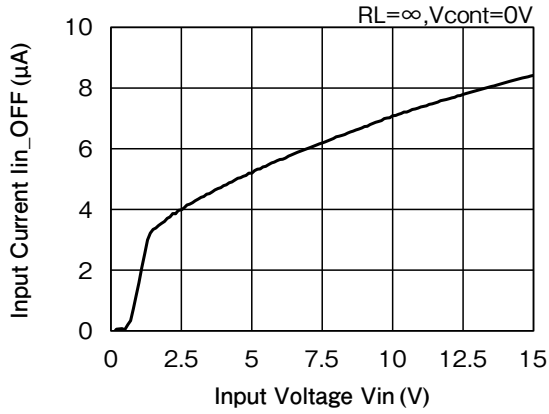

**Input Current - Input Voltage**

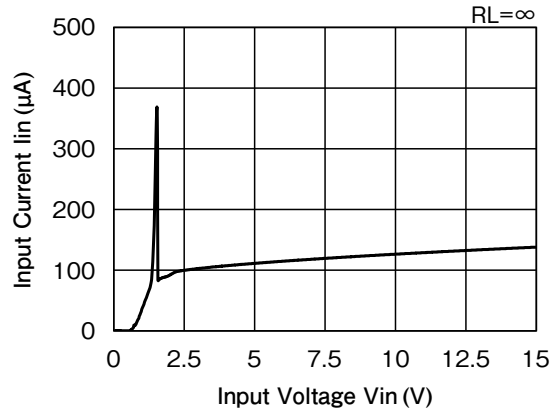

**Output Voltage - Input Voltage**

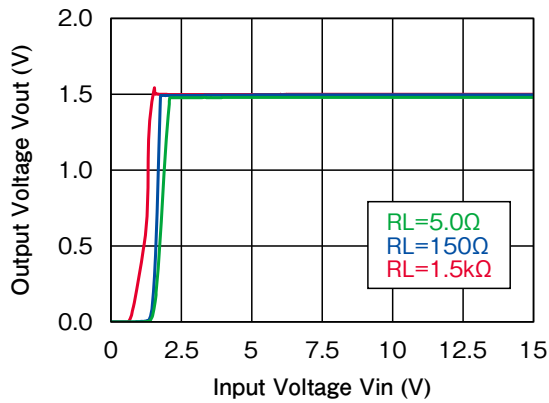

**Line Regulation**

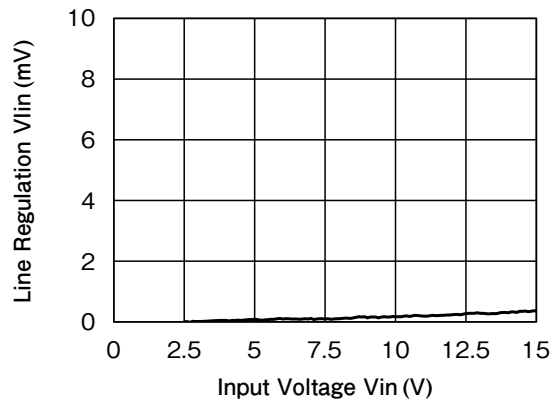

**Load Regulation**

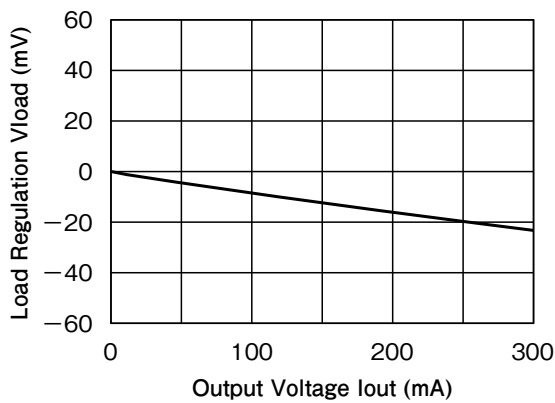

**Vout Temperature Coefficient**

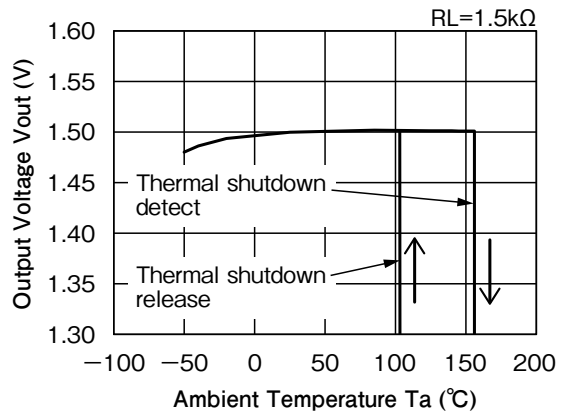

• Any products mentioned in this catalog are subject to any modification in their appearance and others for improvements without prior notification.  
 • The details listed here are not a guarantee of the individual products at the time of ordering. When using the products, you will be asked to check their specifications.

■ Output Voltage – Output Current

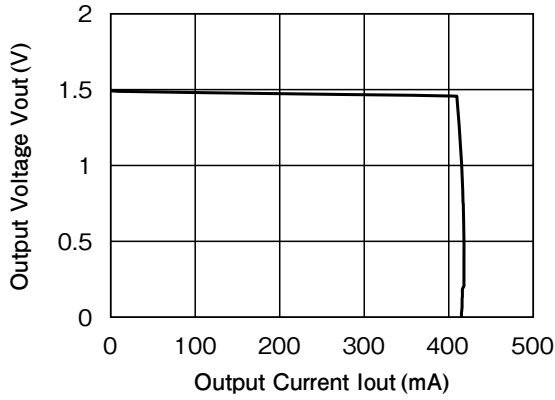

■ Cont Pin Input Current – Cont Voltage

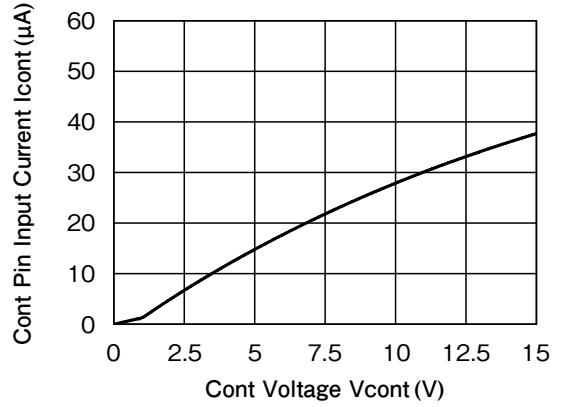

■ Output Noise Voltage

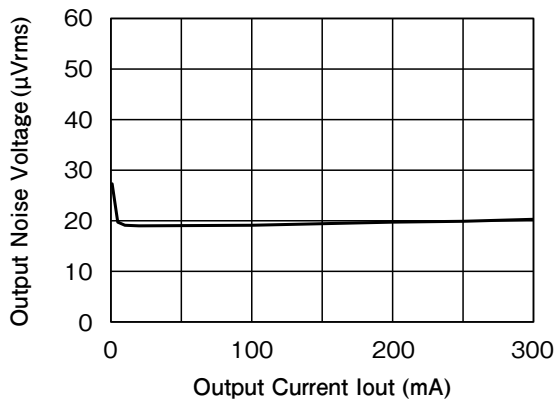

■ Ripple Rejection

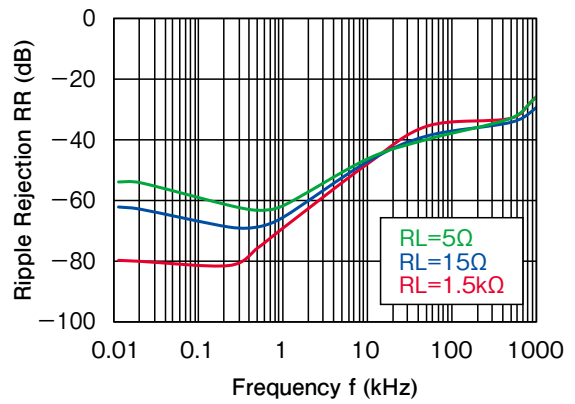

■ ESR stable area

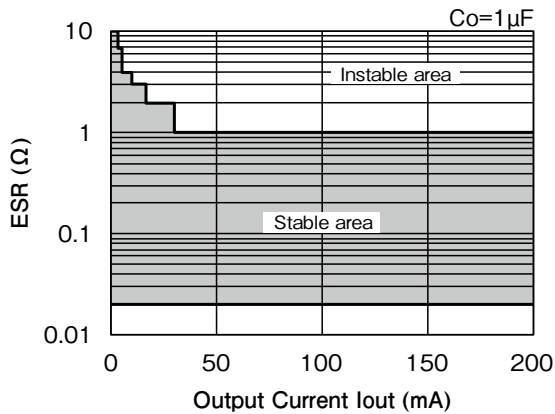

Cont Rise Characteristics

$V_{in}=2.5V, V_{cont}=0 \rightarrow 1.4V, C_n=0.01\mu F, I_o=1mA$

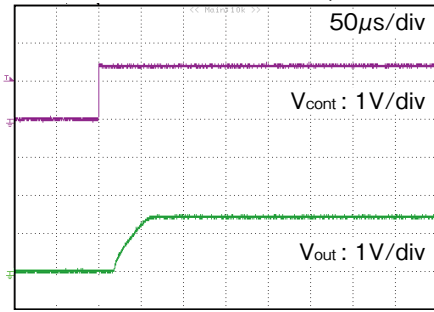

$V_{in}=2.5V, V_{cont}=0 \rightarrow 1.4V, C_n=0.01\mu F, I_o=1mA$

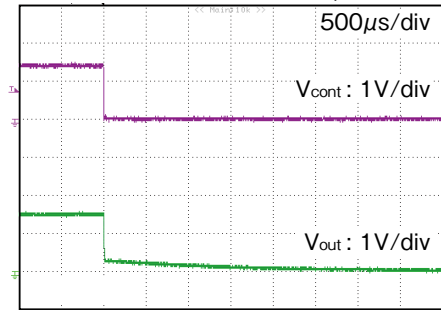

$V_{in}=2.5V, V_{cont}=0 \rightarrow 1.4V, C_n=0.1\mu F, I_o=1mA$

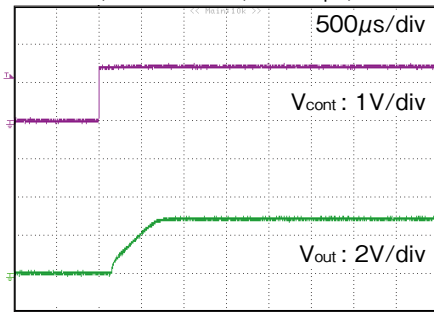

$V_{in}=2.5V, V_{cont}=0 \rightarrow 1.4V, C_n=0.1\mu F, I_o=1mA$

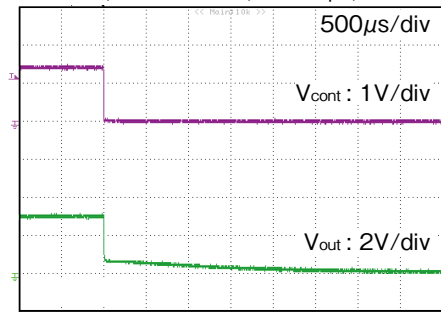

Load Transient Characteristics

$I_{out}=1mA \leftrightarrow 100mA$

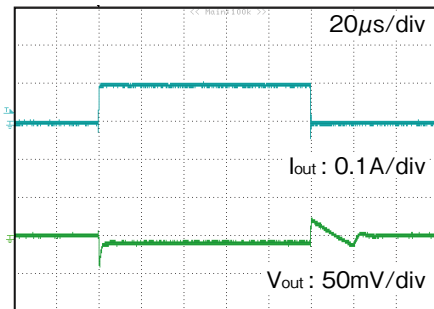

$I_{out}=1mA \leftrightarrow 300mA$

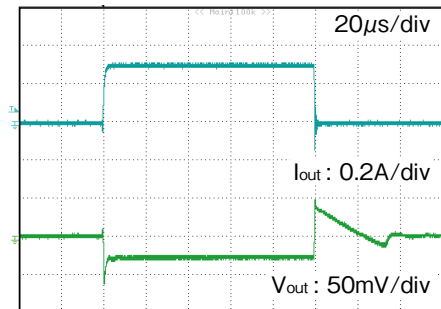

**Characteristics (Vo=3.5V)** (Except where noted otherwise Vin=Vo+1V, Vcont=1.4V, Cin=1μF, Co=1μF, Cn=0.01μF, Ta=25°C)

**Input Current (OFF) - Input Voltage**

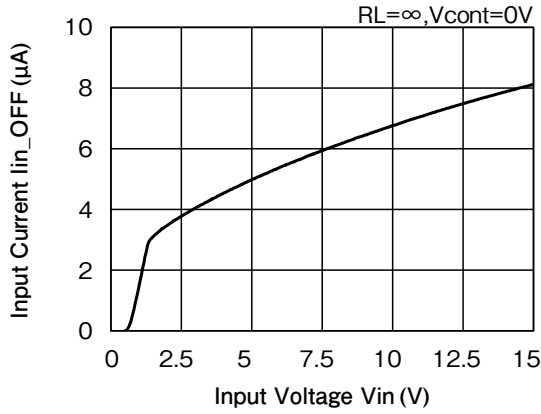

**Input Current - Input Voltage**

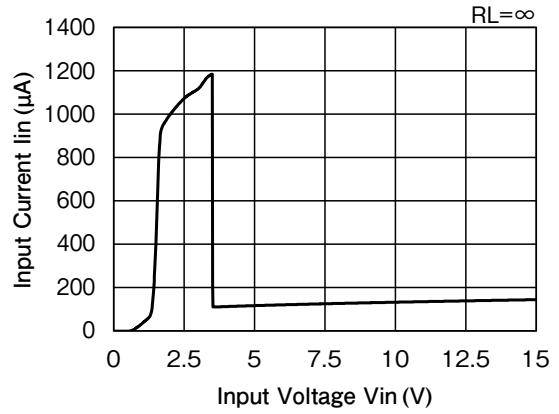

**Output Voltage - Input Voltage**

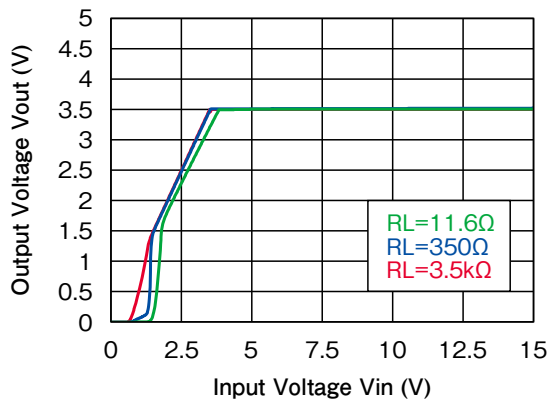

**Line Regulation**

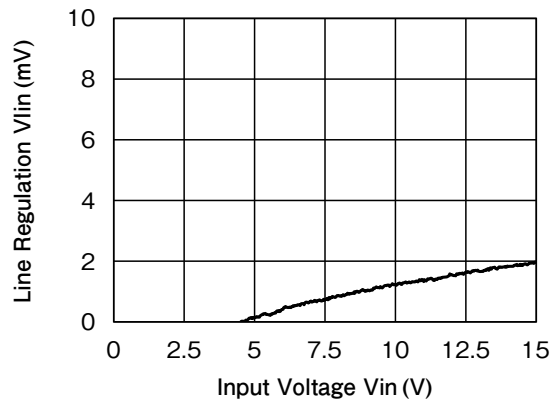

**Load Regulation**

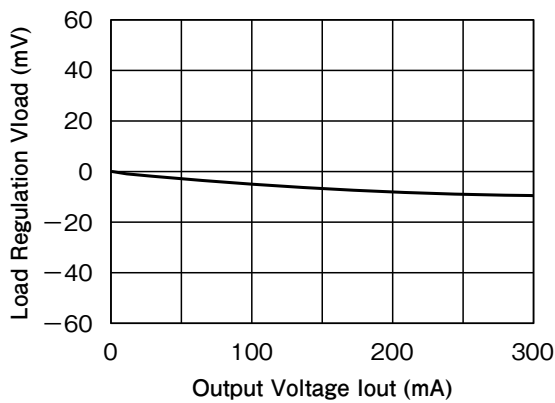

**Vout Temperature Coefficient**

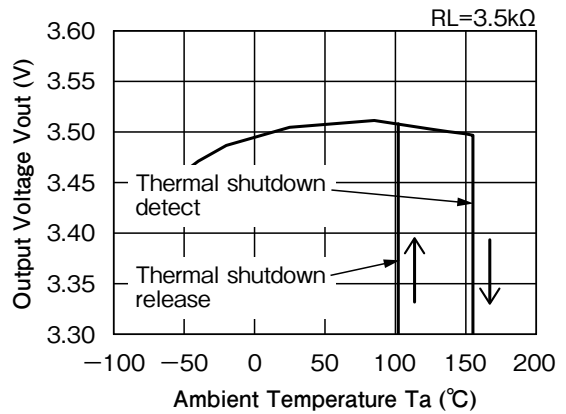

• Any products mentioned in this catalog are subject to any modification in their appearance and others for improvements without prior notification.  
 • The details listed here are not a guarantee of the individual products at the time of ordering. When using the products, you will be asked to check their specifications.

■ Output Voltage – Output Current

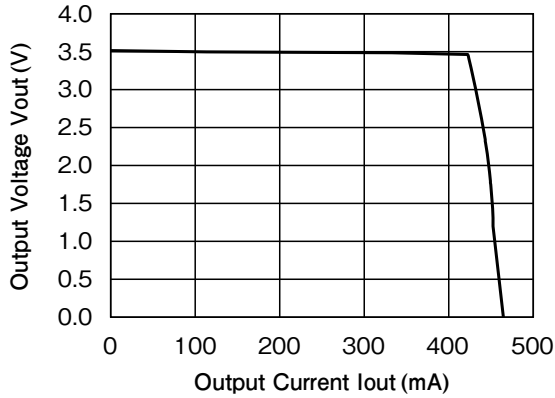

■ Dropout Voltage – Output Current

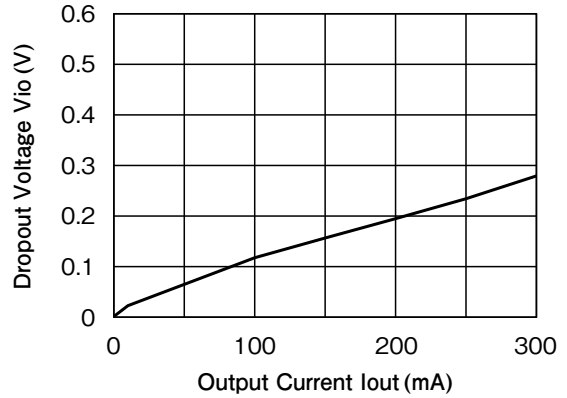

■ Cont Pin Input Current – Cont Voltage

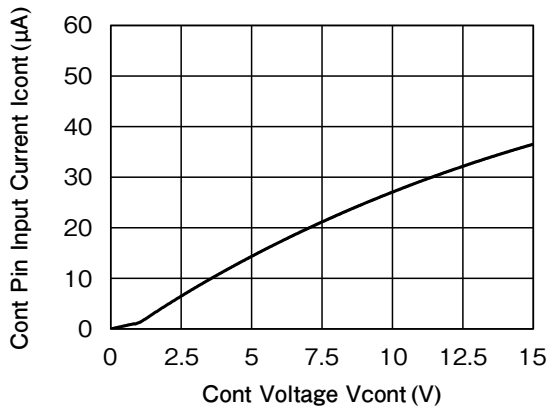

■ Output Noise Voltage

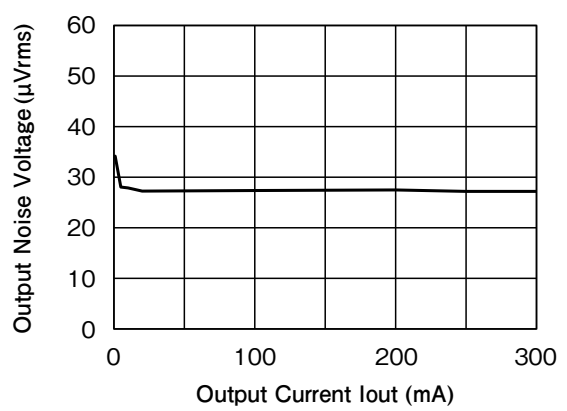

■ Ripple Rejection

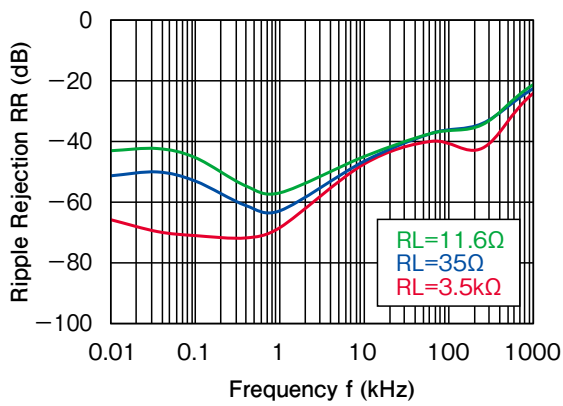

■ ESR stable area

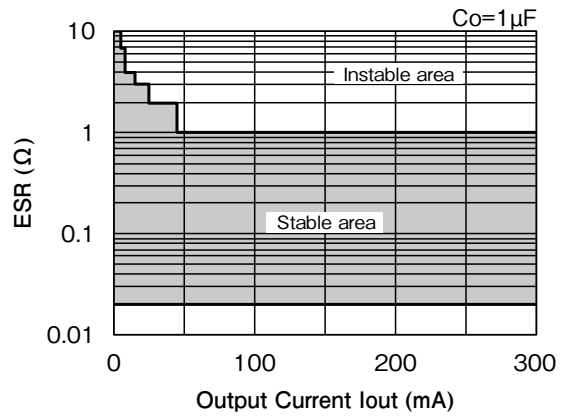

Cont Rise Characteristics

$V_{in}=4.5V, V_{cont}=0 \rightarrow 1.4V, C_n=0.01\mu F, I_o=1mA$

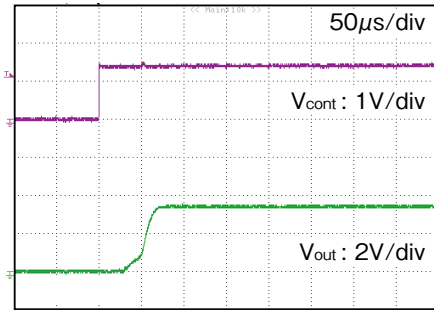

$V_{in}=4.5V, V_{cont}=0 \rightarrow 1.4V, C_n=0.01\mu F, I_o=1mA$

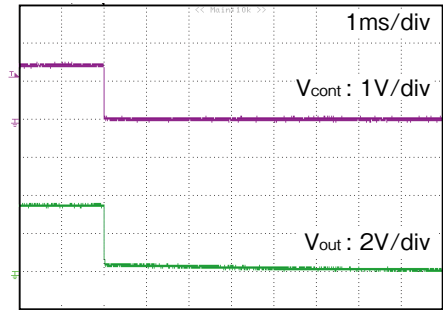

$V_{in}=4.5V, V_{cont}=0 \rightarrow 1.6V, C_n=0.1\mu F, I_o=1mA$

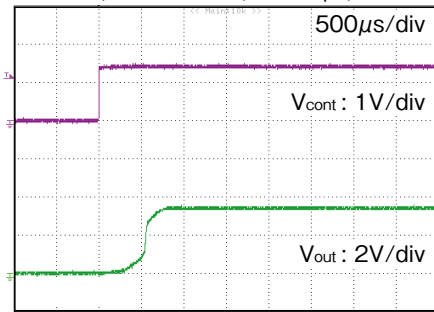

$V_{in}=4.5V, V_{cont}=0 \rightarrow 1.6V, C_n=0.1\mu F, I_o=1mA$

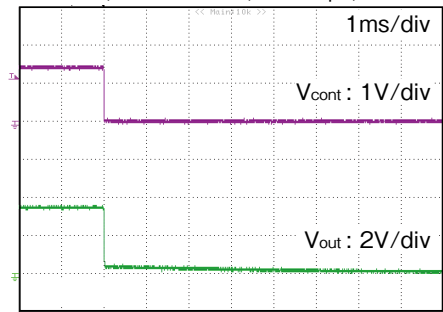

Load Transient Characteristics

$I_{out}=1mA \leftrightarrow 100mA$

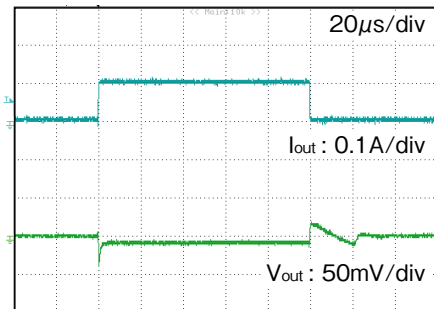

$I_{out}=1mA \leftrightarrow 300mA$

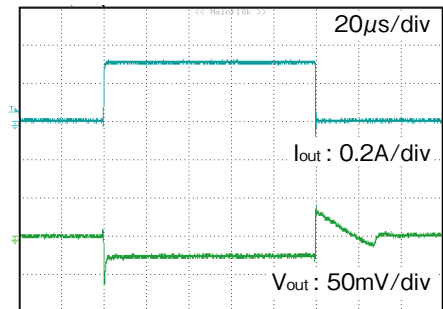

**Characteristics (Vo=5.0V)** (Except where noted otherwise Vin=Vo+1V, Vcont=1.4V, Cin=1μF, Co=1μF, Cn=0.01μF, Ta=25°C)

**Input Current (OFF) - Input Voltage**

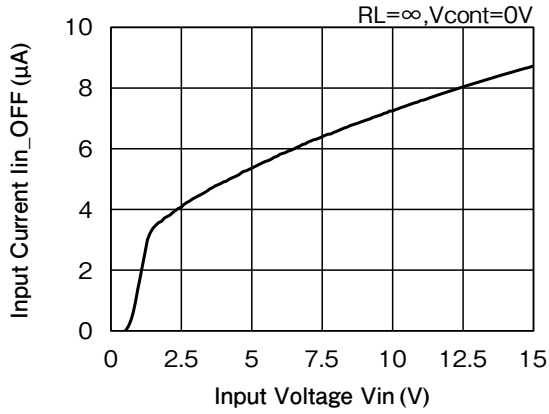

**Input Current - Input Voltage**

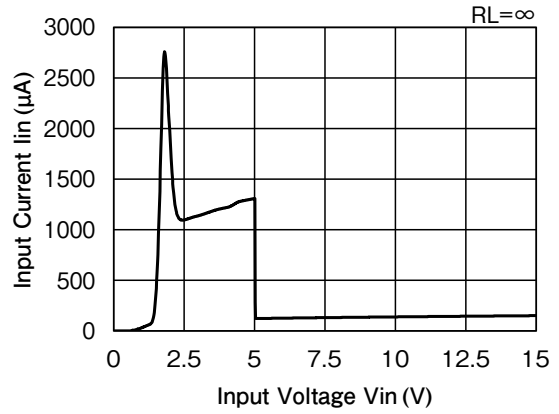

**Output Voltage - Input Voltage**

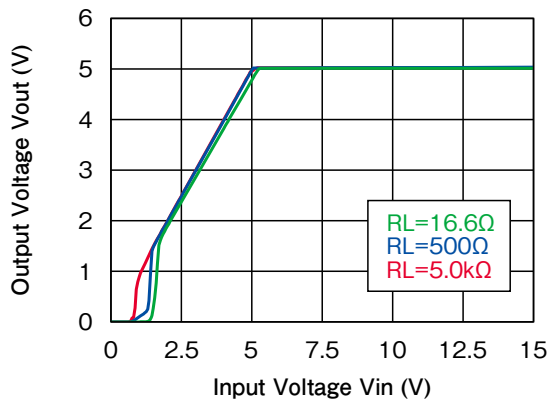

**Line Regulation**

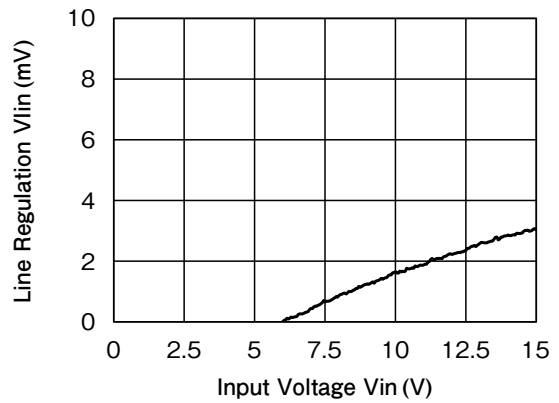

**Load Regulation**

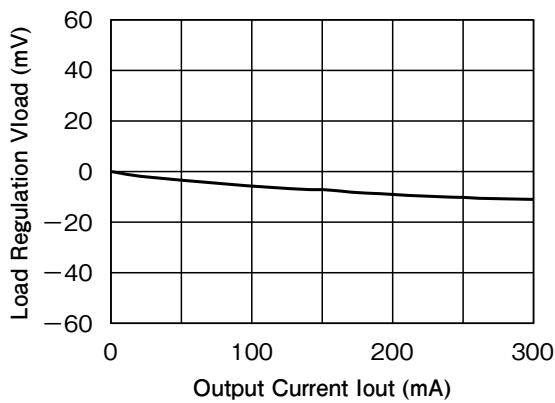

**Vout Temperature Coefficient**

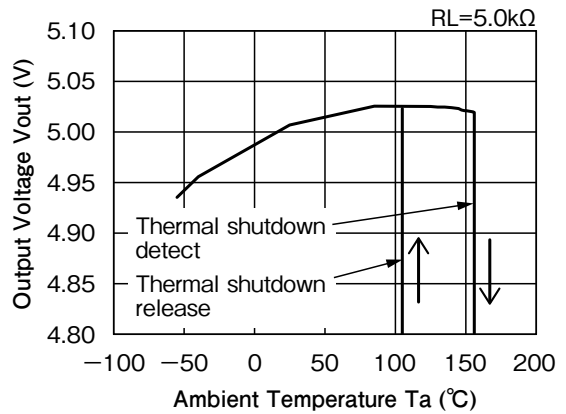

• Any products mentioned in this catalog are subject to any modification in their appearance and others for improvements without prior notification.  
 • The details listed here are not a guarantee of the individual products at the time of ordering. When using the products, you will be asked to check their specifications.



■ Output Voltage – Output Current

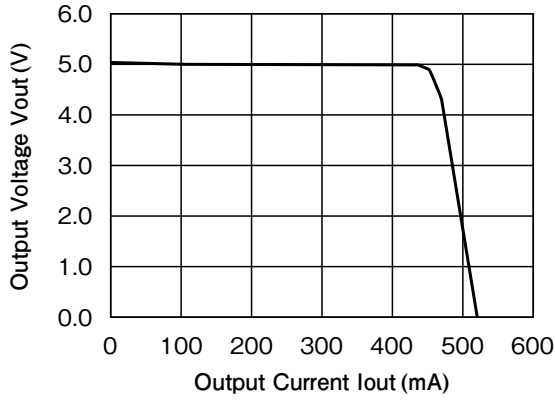

■ Dropout Voltage – Output Current

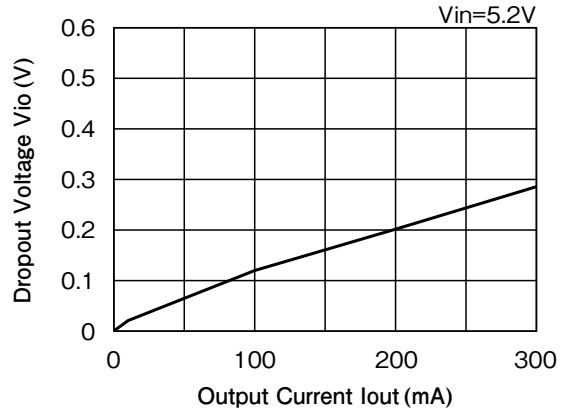

■ Cont Pin Input Current – Cont Voltage

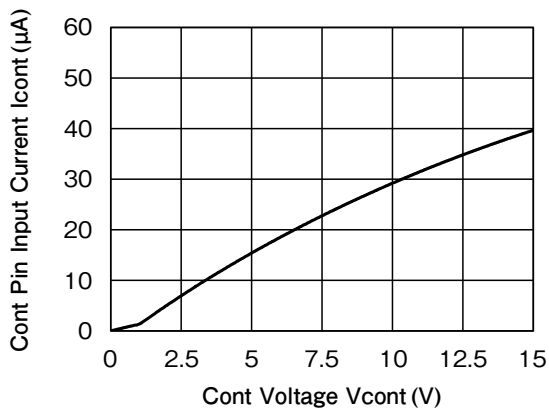

■ Output Noise Voltage

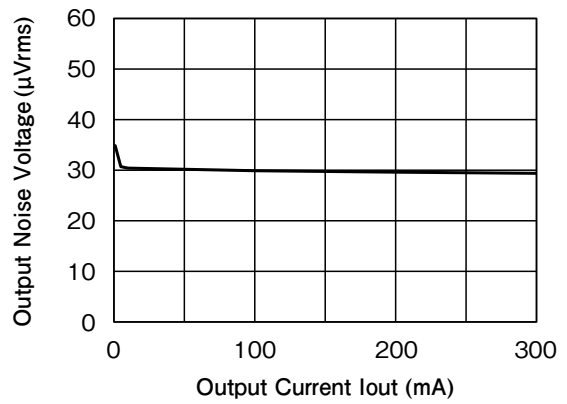

■ Ripple Rejection

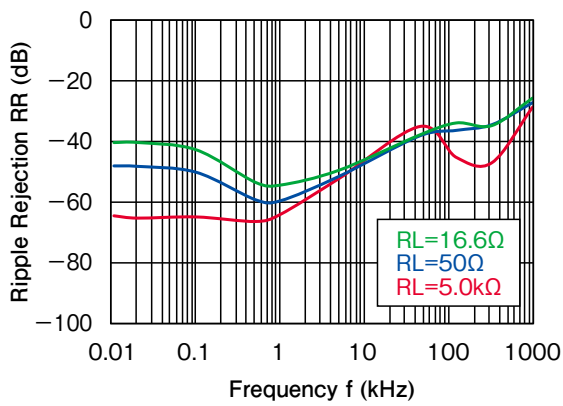

■ ESR stable area

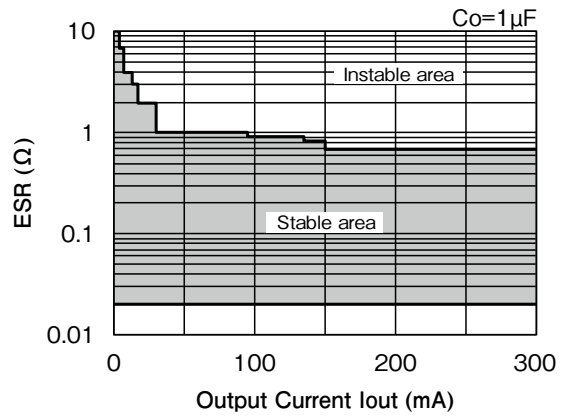

Cont Rise Characteristics

$V_{in}=6.0V, V_{cont}=0 \rightarrow 1.4V, C_n=0.01\mu F, I_o=1mA$

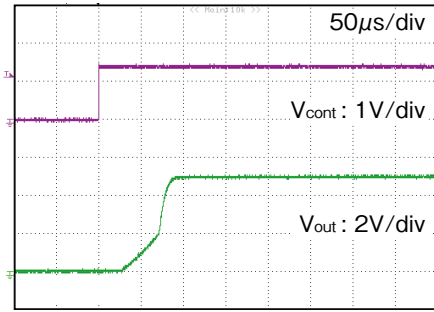

$V_{in}=6.0V, V_{cont}=0 \rightarrow 1.4V, C_n=0.01\mu F, I_o=1mA$

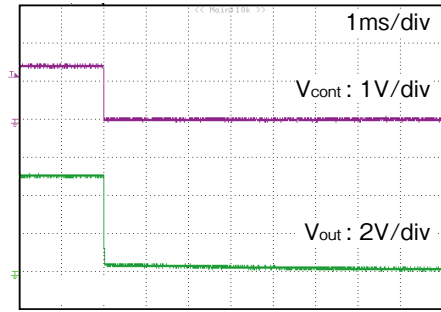

$V_{in}=6.0V, V_{cont}=0 \rightarrow 1.4V, C_n=0.1\mu F, I_o=1mA$

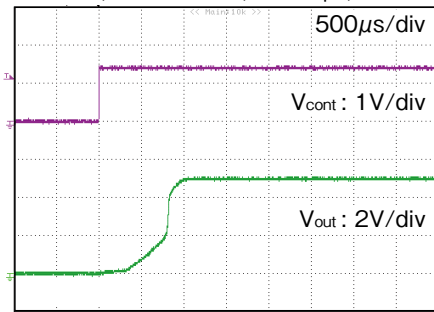

$V_{in}=6.0V, V_{cont}=0 \rightarrow 1.4V, C_n=0.1\mu F, I_o=1mA$

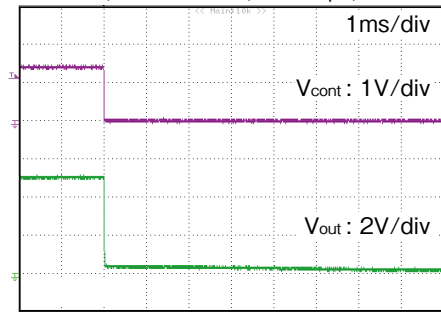

Load Transient Characteristics

$I_{out}=1mA \leftrightarrow 100mA$

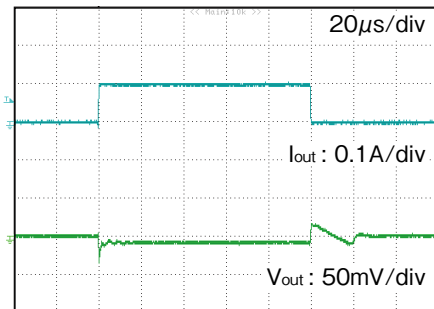

$I_{out}=1mA \leftrightarrow 300mA$

