

# 250mA/300mA LDO Monolithic IC MM1886 Series

## Outline

This IC is a 250mA/300mA Low dropout regulator IC with ON/OFF control.  
The IC applies to a standard home equipments, for a maximum operating voltage is 14V.

## Features

- |                              |  |
|------------------------------|--|
| 1. Maximum operating voltage | 14V  |
| 2. Output current            | 250mA (Vo=1.5V~2.9V)<br>300mA (Vo=3.0V~5.0V)     |
| 3. No load input current     | 75µA typ.  |
| 4. Input current(OFF)        | 1µA max.   |
| 5. Output voltage range      | 1.5~5.0V   |
| 6. Output voltage accuracy   | ±2%  |
| 7. Dropout voltage           | 400mV typ. (Io=250mA)<br>450mV typ. (Io=300mA)   |
| 8. Line regulation           | 0.1%/V max.                                      |
| 9. Load regulation           | 75mV max. (Io=1~250mA)<br>90mV max. (Io=1~300mA) |
| 10. Ripple rejection         | 70dB typ. (f=1kHz)                               |
| 11. Output Capacitor         | 1µF  |
| 12. ON/OFF control           |  |
| 13. Thermal shutdown         |  |

## Package

- SOT-25A
- SOT89-5A
- SSON-6A

## Applications

- 1. TV
- 2. BD recorder
- 3. Printer
- 4. Game

### Block Diagram

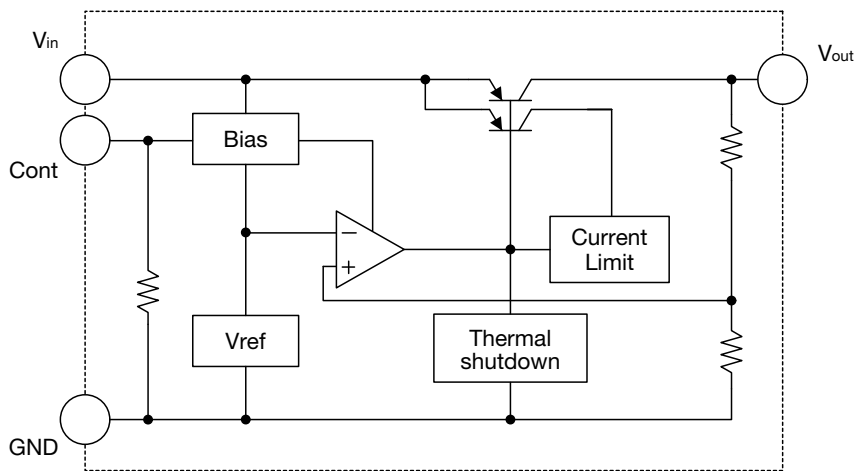

### Pin Assignment

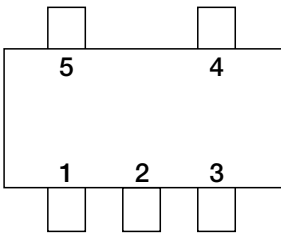

SOT-25A  
(TOP VIEW)

1	Cont
2	GND
3	NC
4	Vout
5	Vin

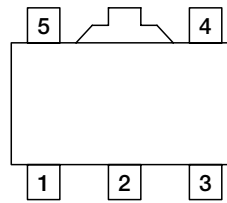

SOT89-5  
(TOP VIEW)

1	NC
2	GND
3	Cont
4	Vin
5	Vout

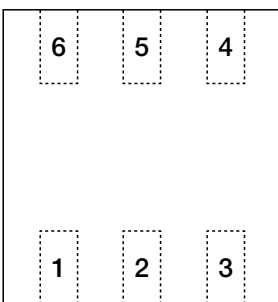

SSON-6A  
(TOP VIEW)

1	Vin
2	NC
3	Vout
4	NC
5	GND
6	Cont

## Pin Description

### SOT-25A

Pin No.	Pin name	Functions	Internal equivalent circuit diagram						
1	Cont	<p>ON/OFF Control pin</p> <table border="1"> <tr> <th>Cont</th> <th>Vout</th> </tr> <tr> <td>H</td> <td>ON</td> </tr> <tr> <td>L</td> <td>OFF</td> </tr> </table> <p>Cont pin must be connected with Vin pin, if it is not used.</p>	Cont	Vout	H	ON	L	OFF	
Cont	Vout								
H	ON								
L	OFF								
2	GND	Ground							
3	NC	No connection							
4	Vout	<p>Output pin</p> <p>The capacitor must be connected with output pin more than 1μF.</p>							
5	Vin	<p>Input pin</p> <p>The capacitor is required to connect with input pin more than 1μF.</p>							

■ SOT89-5A

Pin No.	Pin name	Functions	Internal equivalent circuit diagram						
1	NC	No connection							
2	GND	Ground							
3	Cont	<p>ON/OFF Control pin</p> <table border="1"> <tr> <th>Cont</th> <th>Vout</th> </tr> <tr> <td>H</td> <td>ON</td> </tr> <tr> <td>L</td> <td>OFF</td> </tr> </table> <p>Cont pin must be connected with Vin pin, if it is not used.</p>	Cont	Vout	H	ON	L	OFF	
Cont	Vout								
H	ON								
L	OFF								
4	Vin	<p>Input pin</p> <p>The capacitor is required to connect with input pin more than 1μF.</p>							
5	Vout	<p>Output pin</p> <p>The capacitor must be connected with output pin more than 1μF.</p>							

SSON-6A

Pin No.	Pin name	Functions	Internal equivalent circuit diagram						
1	Vin	<p>Input pin</p> <p>The capacitor is required to connect with input pin more than 1μF.</p>							
2,4	NC	No connection							
3	Vout	<p>Output pin</p> <p>The capacitor must be connected with output pin more than 1μF.</p>							
5	GND	Ground							
6	Cont	<p>ON/OFF Control pin</p> <table border="1" style="margin-left: auto; margin-right: auto;"> <tr> <td>Cont</td> <td>Vout</td> </tr> <tr> <td>H</td> <td>ON</td> </tr> <tr> <td>L</td> <td>OFF</td> </tr> </table> <p>Cont pin must be connected with Vin pin, if it is not used.</p>	Cont	Vout	H	ON	L	OFF	
Cont	Vout								
H	ON								
L	OFF								

**Absolute Maximum Ratings** (Except where noted otherwise Ta=25°C)

Item	Symbol	Ratings		Units
Storage Temperature	Tstg	-55~+150		°C
Operating Temperature	Topr	-40~+85		°C
Supply Voltage	Vin	-0.3~+15		V
Cont PIN Voltage	Vcont	-0.3~+15		
Output Current	Iout	400		mA
Power Dissipation	Pd	350(Note1)	SOT-25A	mW
		1000(Note2)	SOT89-5A	
		1300(Note3)	SSON-6A	

Note1 : With the PC Board of glass epoxy. (60 × 40 × 1.6mm)

Note2 : With the PC Board of glass epoxy. (114.3 × 76.2 × 1.6mm)

Note3 : With the PC Board of glass epoxy. (25 × 25 × 1.6mm)

**Recommended Operating Conditions** (Except where noted otherwise Ta=25°C)

Item	Symbol	Ratings		Units
Output Current	Iout	0~250 (Vo=1.5~2.9V)		mA
		0~300 (Vo=3.0~5.0V)		
Operating Voltage	Vop	1.8~14		V

**Electrical Characteristics 1** (Except where noted otherwise  $V_{in}=V_o(\text{typ.})+1V$ ,  $I_o=1mA$ ,  $V_{cont}=1.6V$ ,  $T_a=25^{\circ}C$ )

Item	Symbol	Measurement conditions	Min.	Typ.	Max.	Units
No-Load Input Current	$I_{cc}$	$I_o=0mA$ $V_{cont}=VDD$		75	120	$\mu A$
Input Current (OFF)	$I_{c\text{off}}$	$V_{cont}=0V$		0	1	$\mu A$
Output Voltage (Note2)	$V_{OUT}$	$I_o=1mA$	$\times 0.98$		$\times 1.02$	V
Dropout Voltage (Note3)	$V_{io}$	$V_{in}=V_o-0.2V$ , $I_o=250mA$		0.40	0.70	V
		$V_{in}=V_o-0.2V$ , $I_o=300mA$		0.45	0.75	
Line Regulation	$\Delta V1$	$V_{in}=V_o+1\sim 14V$ , $I_o=1mA$			0.1	%/V
Load Regulation	$\Delta V2$	$I_o=1\sim 250mA$ (1.5V~2.9V)		18	75	mV
		$I_o=1\sim 300mA$ (3.0V~5.0V)		20	90	
Vout Temperature Coefficient (Note1)	$\Delta V_{out} / \Delta T$	$T_a=-40\sim +85^{\circ}C$		$\pm 100$		ppm/ $^{\circ}C$
Ripple Rejection (Note1)	RR	$f=1kHz$ $V_{ripple}=1V_{p-p}$ , $I_o=10mA$		70		dB
Cont Pin Input Current	$I_{cont}$	$V_{cont}=1.6V$		3	12	$\mu A$
Cont Pin High Threshold Level	$V_{contH}$		1.6			V
Cont Pin Low Threshold Level	$V_{contL}$				0.3	V

Note1 : The parameter is guaranteed by design.

Note2 : Please refer to another page.

Note3 : The parameter is not guaranteed in the model less than  $V_{OUT}=2V$ .

**Electrical Characteristics 2** (Except where noted otherwise  $V_{in}=V_o(\text{typ.})+1V$ ,  $I_o=1mA$ ,  $V_{cont}=1.6V$ ,  $T_a=25^\circ C$ )

Model No.	Measurement Conditions	Output voltage (V)		
		Min.	Typ.	Max.
MM1886A15	Io=1mA	1.470	1.5	1.530
MM1886A16		1.568	1.6	1.632
MM1886A17		1.666	1.7	1.734
MM1886A18		1.764	1.8	1.836
MM1886A19		1.862	1.9	1.938
MM1886A20		1.960	2.0	2.040
MM1886A21		2.058	2.1	2.142
MM1886A22		2.156	2.2	2.244
MM1886A23		2.254	2.3	2.346
MM1886A24		2.352	2.4	2.448
MM1886A25		2.450	2.5	2.550
MM1886A26		2.548	2.6	2.652
MM1886A27		2.646	2.7	2.754
MM1886A28		2.744	2.8	2.856
MM1886A29		2.842	2.9	2.958
MM1886A30		2.940	3.0	3.060
MM1886A31		3.038	3.1	3.162
MM1886A32		3.136	3.2	3.264
MM1886A33		3.234	3.3	3.366
MM1886A34		3.332	3.4	3.468
MM1886A35		3.430	3.5	3.570
MM1886A36		3.528	3.6	3.672
MM1886A37		3.626	3.7	3.774
MM1886A38		3.724	3.8	3.876
MM1886A39		3.822	3.9	3.978
MM1886A40		3.920	4.0	4.080
MM1886A41		4.018	4.1	4.182
MM1886A42		4.116	4.2	4.284
MM1886A43		4.214	4.3	4.386
MM1886A44		4.312	4.4	4.488
MM1886A45		4.410	4.5	4.590
MM1886A46		4.508	4.6	4.692
MM1886A47	4.606	4.7	4.794	
MM1886A48	4.704	4.8	4.896	
MM1886A49	4.802	4.9	4.998	
MM1886A50	4.900	5.0	5.100	

• Any products mentioned in this catalog are subject to any modification in their appearance and others for improvements without prior notification.  
 • The details listed here are not a guarantee of the individual products at the time of ordering. When using the products, you will be asked to check their specifications.



## Measuring Circuit

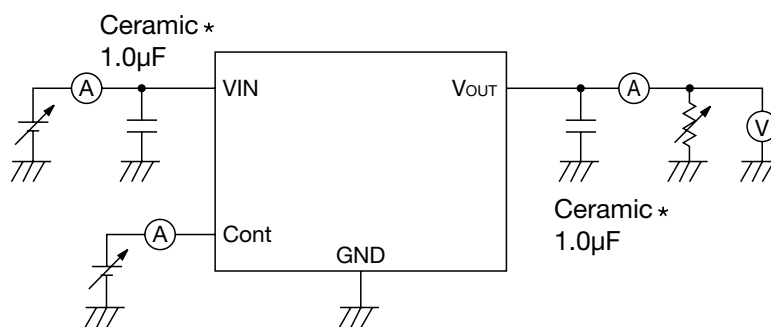

## Application Circuit

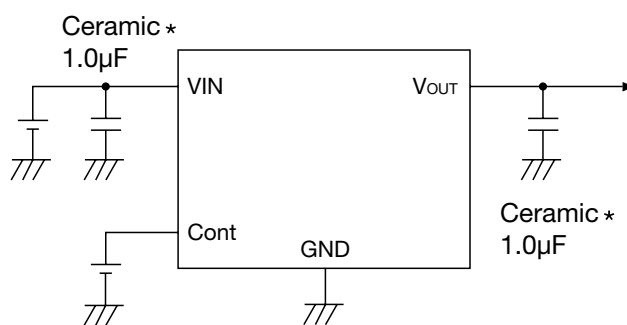

\* Temperature Characteristics : B

(Reference example of external parts)

- Output capacitor                      Ceramic capacitor 1.0µF
- Input capacitor                        Ceramic capacitor 1.0µF

· In the event a problem which may affect industrial property or any other rights of us or a third party is encountered during the use of information described in these circuit, we shall not be liable for any such problem, nor grant a license therefore.

· Note

1. There is a possibility with deterioration and destruction of IC when using it exceeding the absolute maximum rating.  
The absolute maximum rating , Never exceed it.  
The functional operation is not assured.
2. There is a possibility that it becomes impossible to maintain this performance and reliability IC original when using it exceeding recommended operation voltage.  
Please use it in recommended operation voltage.
3. Due to restrictions on the package power dissipation, the output current value may not be satisfied.  
Attention should be paid to the power dissipation of the package when the output current is large or the voltage between Input and Output is high.
4. The output capacitor is required between output and GND to prevent oscillation.
5. The ESR of capacitor must be defined in ESR stability area.  
It is possible to use a ceramic capacitor without ESR resistance for output.  
The ceramic capacitor must be used more than 1.0 $\mu$ F and B temperature characteristics.
6. The wire of VDD and GND is required to print full ground plane for noise and stability.
7. The input capacitor must be connected a distance of less than 1cm from input pin.
8. It is able to an unstable operation when you use the capacitor with intense capacitance change  
The capacitor has the dependency at the power-supply voltage and the temperature.  
The capacity value changes by the environment used. Please evaluate IC in the set.
9. There is a possibility of becoming an unstable operation. when using it with Dropout voltage no margin.  
Please evaluate it enough when there is no margin in Dropout voltage.
10. In case the output voltage is above the input voltage, the overcurrent flow by internal parasitic diode from output to input. In such application, the external bypass diode must be connected between output and input pin.

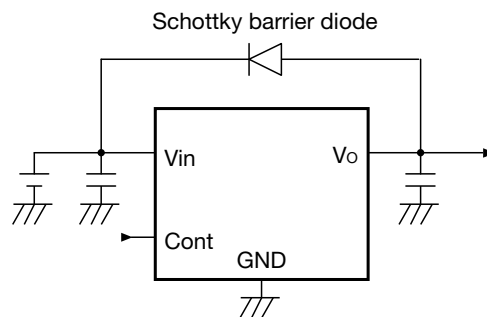

11. The overcurrent protection circuit of the vertical type is built into this IC.
12. There is a possibility that IC generates heat when the output terminal is short-circuited.  
However, the thermal shutdown circuit operates, and it will do operation that protects IC.  
The thermal shutdown circuit is designed only to shut the IC off to prevent thermal runaway.  
Do not continue to use the IC in an environment where the operation of this circuit is assumed.  
The characteristic changes depending on the substrate condition.  
Please evaluate IC in the set.
13. The hysteresis circuit is not built into the thermal shutdown circuit.  
It returns automatically in temperature returned after it shuts down by self-generation of heat.  
After it returns, it shuts down again by self-generation of heat.  
It is necessary to change the environment used (IC consumption, temperature) if it operates in upper cycle.

## About Power Dissipation

The Power dissipation change if board to mount IC change because radiative heat fix at board. It is reference data below, Evaluate IC in the set.

### MM1886AxxNRE

1. PC Board of glass epoxy

Board size 60mm×40mm t=1.6mm Copper foil area 60%  
 Power dissipation 350mW Ta=25°C

2. JEDEC51-7 standard

Board size 114.3mm×76.2mm t=1.6mm Copper foil area 80%  
 Power dissipation 700mW Ta=25°C (It is reference value measured by JEDEC51-7 standard.)

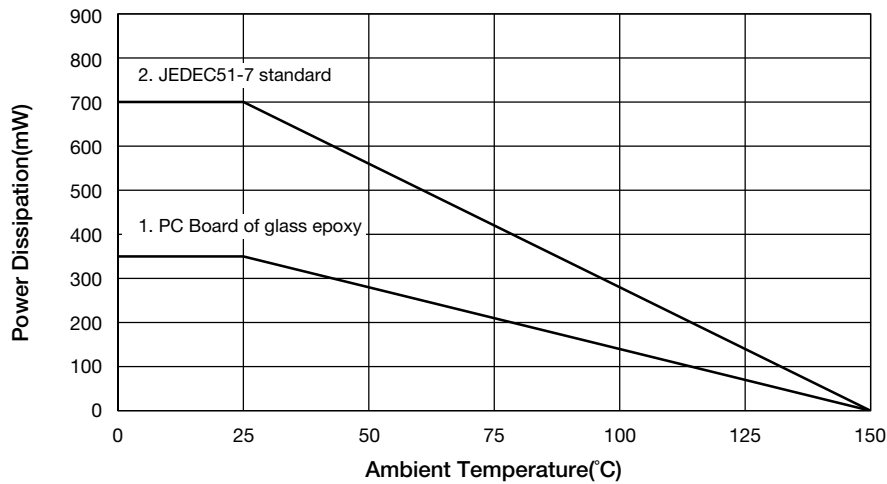

### MM1886AxxPRE

1. PC Board of glass epoxy

Board size 50mm×50mm t=1.6mm Copper foil area 80%  
 Power dissipation 690mW Ta=25°C

2. JEDEC51-7 standard

Board size 114.3mm×76.2mm t=1.6mm Copper foil area 80%  
 Power dissipation 1780mW Ta=25°C (It is reference value measured by JEDEC51-7 standard.)

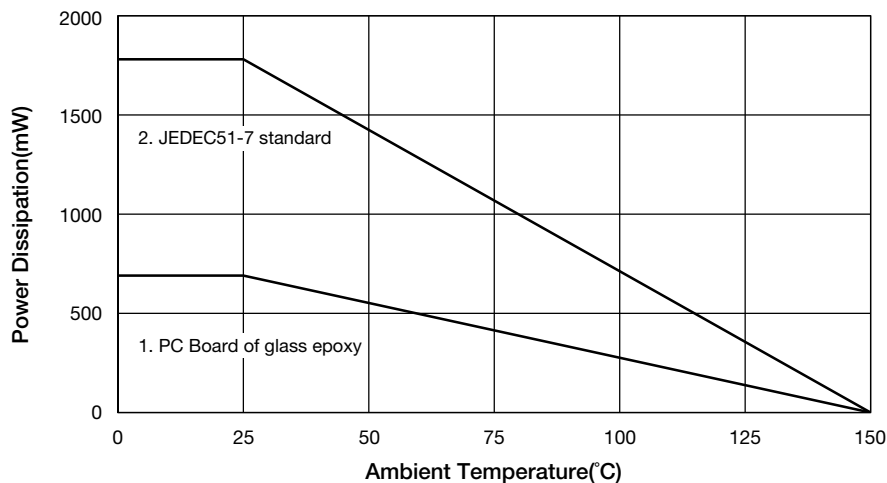

• Any products mentioned in this catalog are subject to any modification in their appearance and others for improvements without prior notification.  
 • The details listed here are not a guarantee of the individual products at the time of ordering. When using the products, you will be asked to check their specifications.

**MM1886AxxRRE**

1. PC Board of glass epoxy

Board size 25mm×25mm t=1.6mm Copper foil area 80%  
 Power dissipation 1300mW Ta=25°C

2. JEDEC51-7 standard

Board size 114.3mm×76.2mm t=1.6mm Copper foil area 80%  
 Power dissipation 1250mW Ta=25°C (It is reference value measured by JEDEC51-7 standard.)

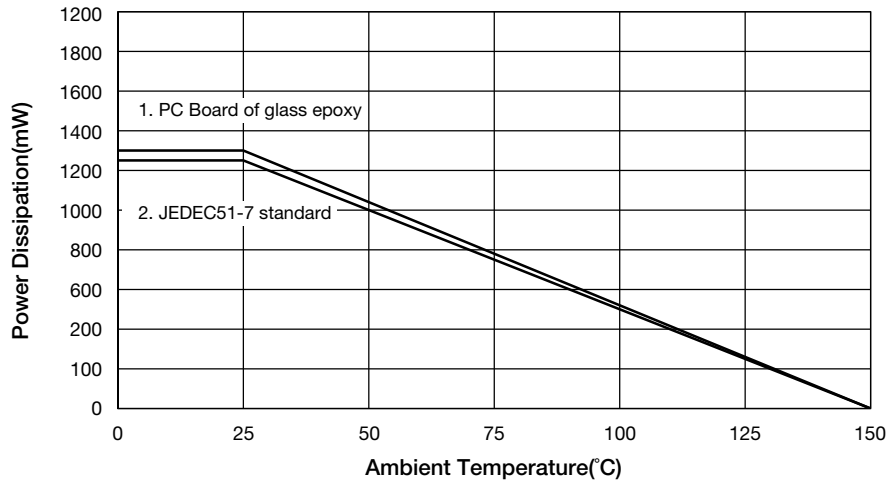

It is recommended to layout the VIA for heat radiation in the GND pattern of reverse (of IC) when there is the GND pattern in the inner layer (in using multiplayer substrate).

By increasing these copper foil pattern area of PCB, Power dissipation improves.

**Characteristics (Vo=1.8V)** (Except where noted otherwise Vin=Vo(typ.)+1V, Iout=1mA, Vcont=Vo+1V, Cin=Co=1μF, Ta=25°C)

■ Input voltage - Input current

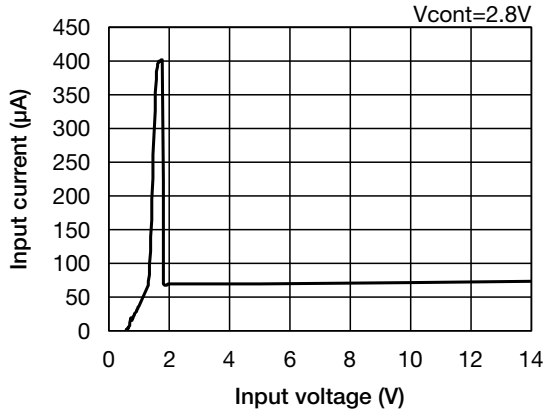

■ Input voltage - Input current

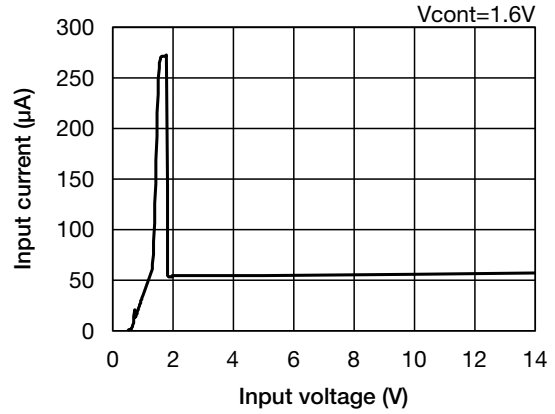

■ Cont pin voltage - Input current

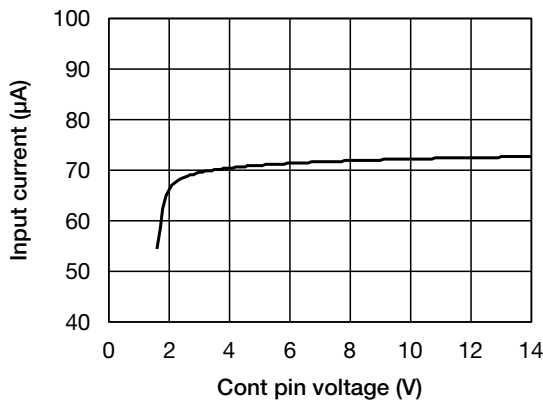

■ Input voltage - Output voltage

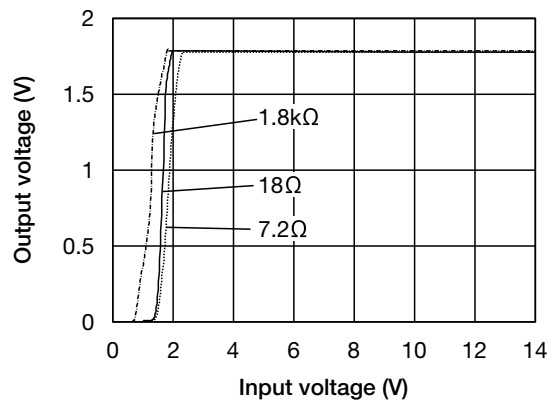

■ Line regulation

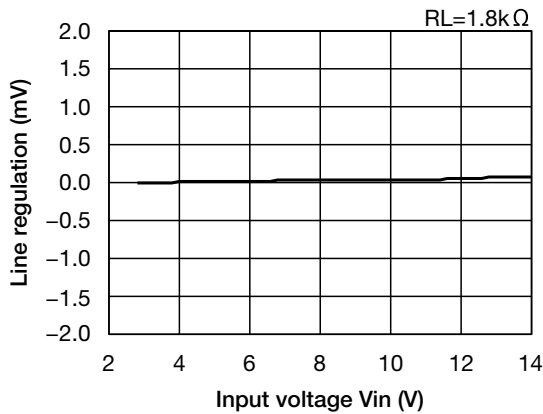

■ Load regulation

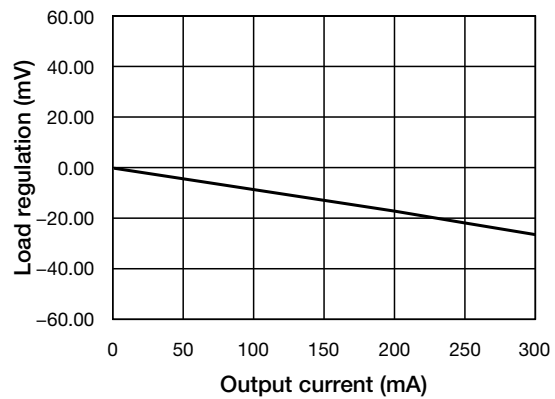

Cont pin voltage - Cont pin current

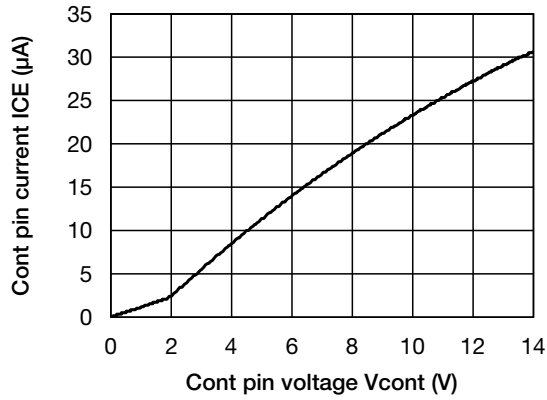

Ambient Temperature - Output voltage

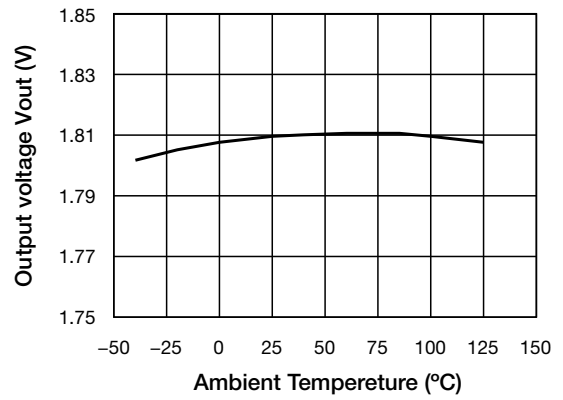

Thermal Shut Down

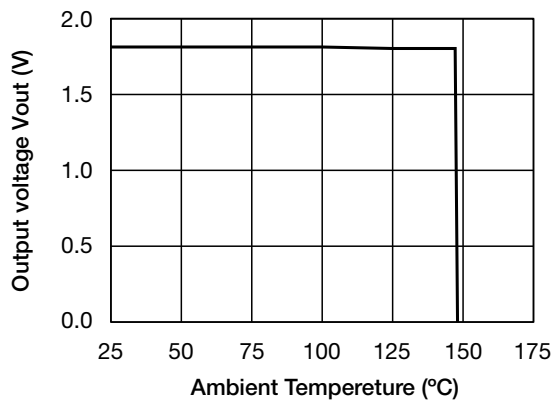

Ripple Rejection

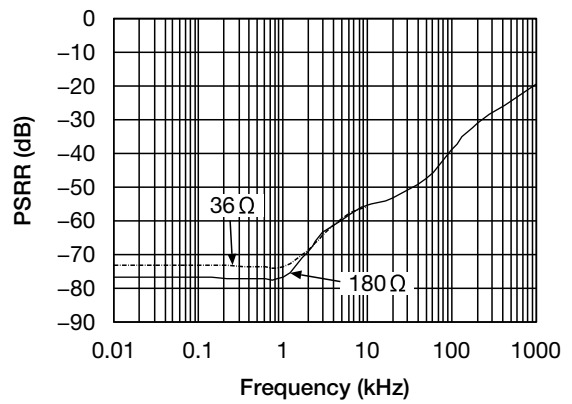

■ Turn-On Transient response

$V_{in}=2.8V, V_{cont}=0 \rightarrow 2.8V, R_L=1.8k\Omega$

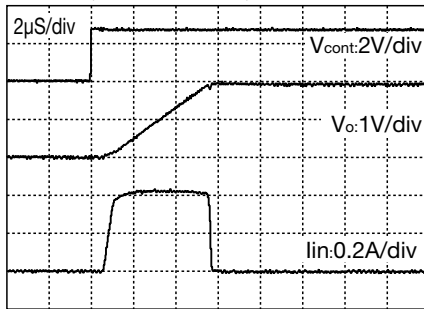

■ Turn-Off Transient response

$V_{in}=2.8V, V_{cont}=2.8 \rightarrow 0V, R_L=1.8k\Omega$

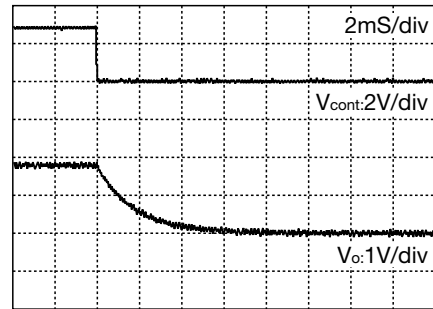

■ Load Transient response

$V_{in}=V_{cont}=2.8V, I_o=1mA \leftrightarrow 100mA, C_{out}=1\mu F$

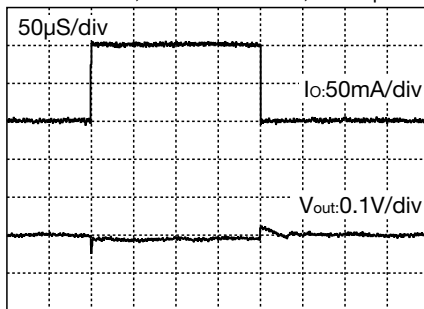

$V_{in}=V_{cont}=2.8V, I_o=1mA \leftrightarrow 200mA, C_{out}=1\mu F$

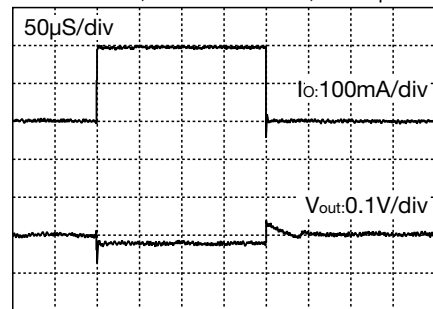

$V_{in}=V_{cont}=2.8V, I_o=1mA \leftrightarrow 300mA, C_{out}=1\mu F$

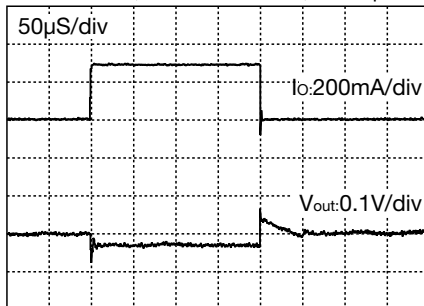

**Characteristics (Vo=3.3V)** (Except where noted otherwise Vin=Vo(typ.)+1V, Iout=1mA, Vcont=Vo+1V, Cin=C0=1μF, Ta=25°C)

■ Input voltage - Input current

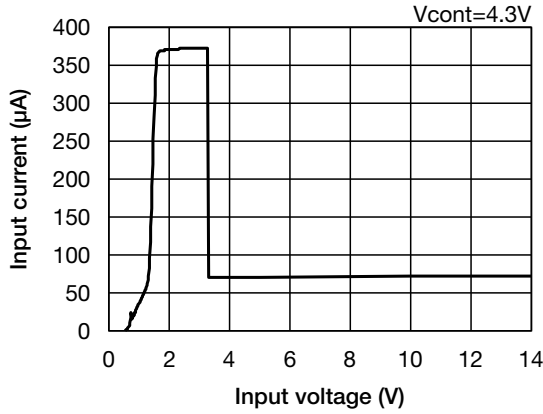

■ Input voltage - Input current

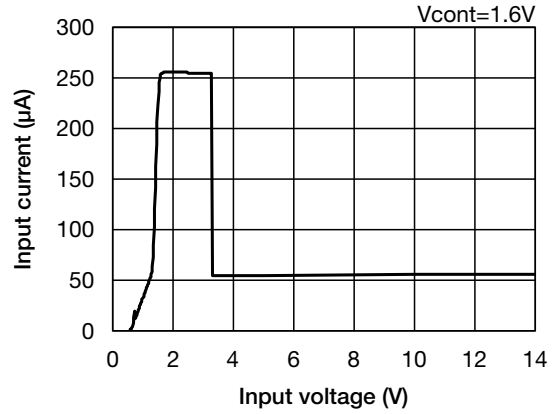

■ Cont pin voltage - Input current

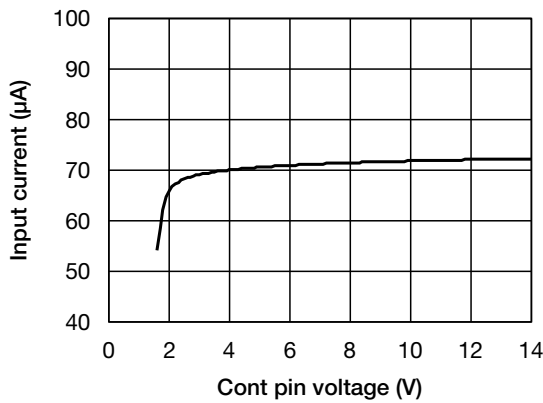

■ Input voltage - Output voltage

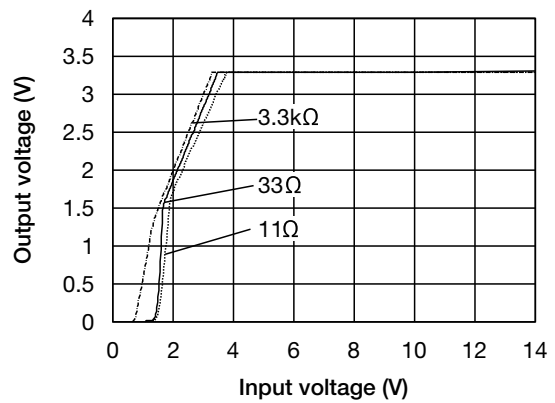

■ Line regulation

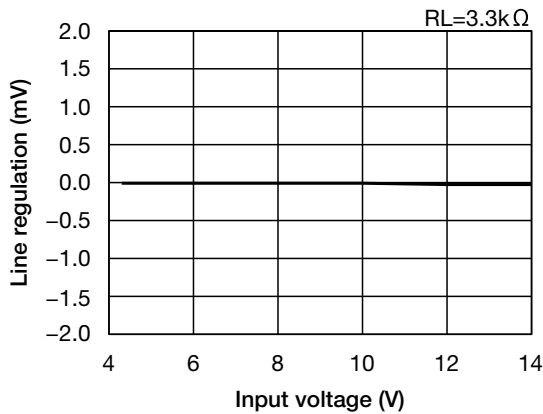

■ Load regulation

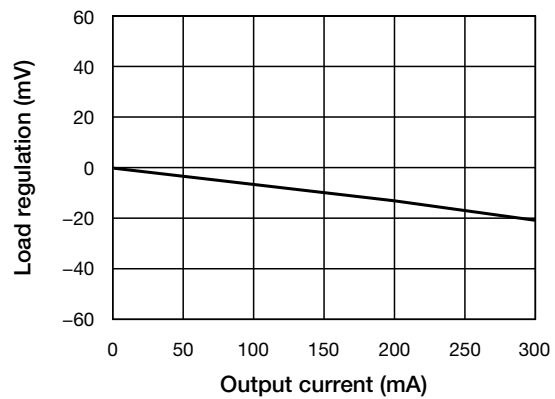

• Any products mentioned in this catalog are subject to any modification in their appearance and others for improvements without prior notification.  
 • The details listed here are not a guarantee of the individual products at the time of ordering. When using the products, you will be asked to check their specifications.



■ Cont pin voltage - Cont pin current

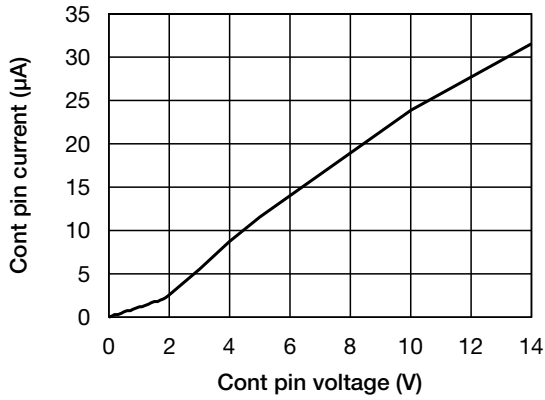

■ Dropout voltage

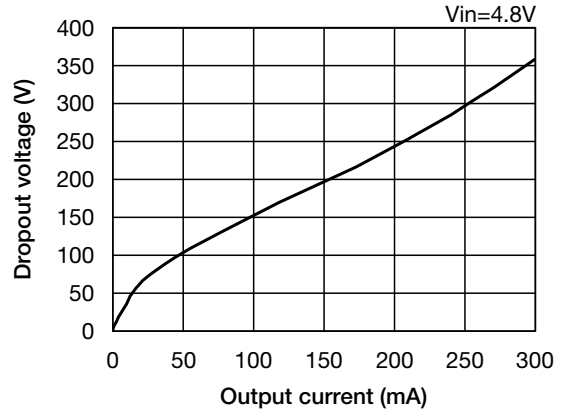

■ Ambient Temperature - Output voltage

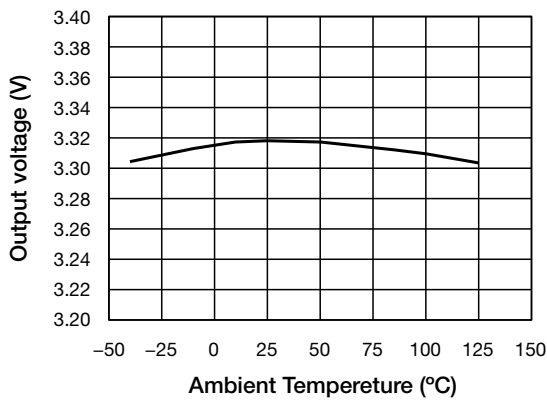

■ Thermal Shut Down

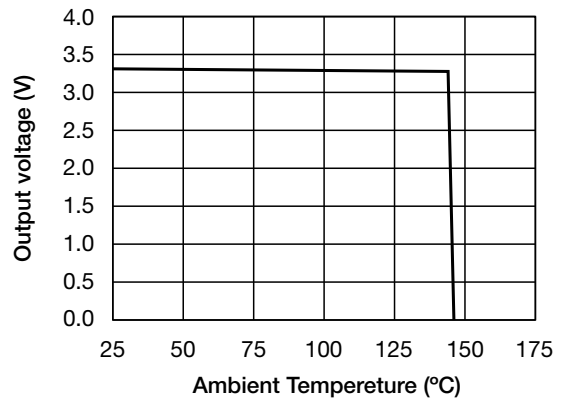

■ Ripple Rejection

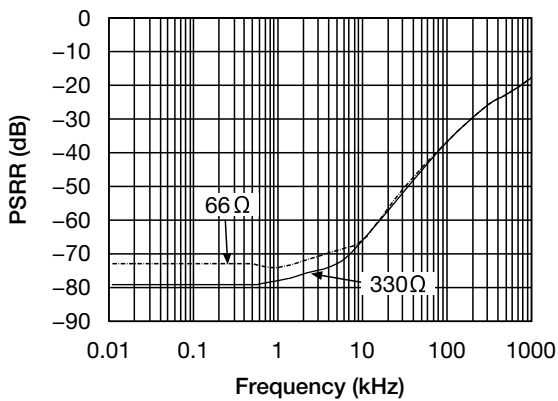

■ Turn-On Transient response

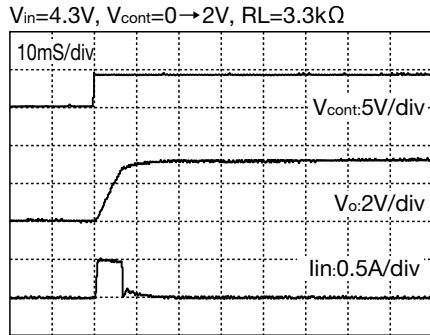

■ Turn-Off Transient response

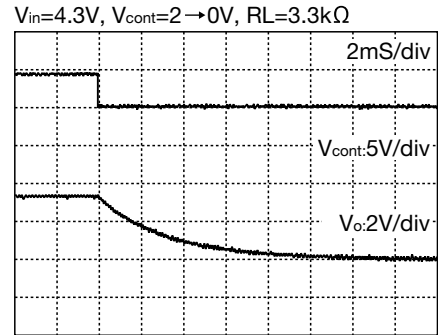

■ Load Transient response

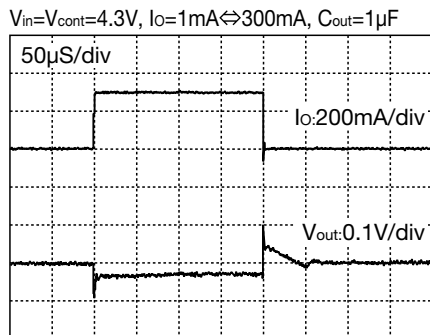
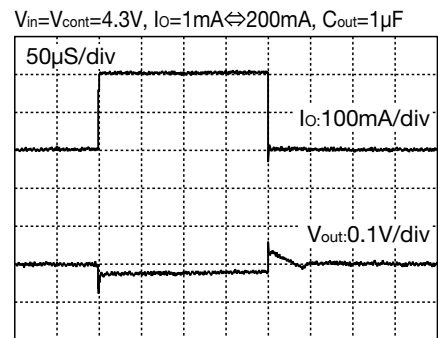
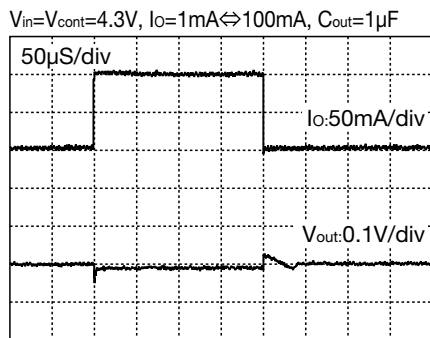

**Characteristics (Vo=5.0V)** (Except where noted otherwise Vin=Vo(typ.)+1V, Iout=1mA, Vcont=Vo+1V, Cin=Co=1μF, Ta=25°C)

■ Input voltage - Input current

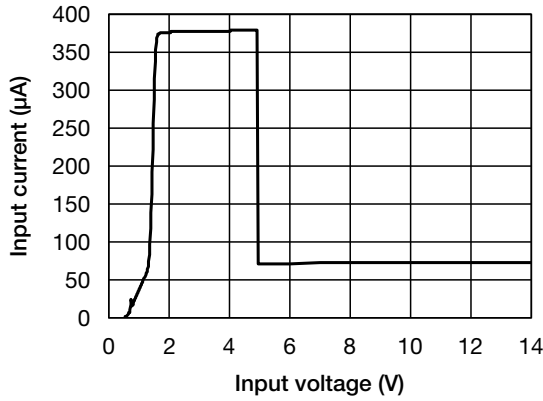

■ Input voltage - Input current

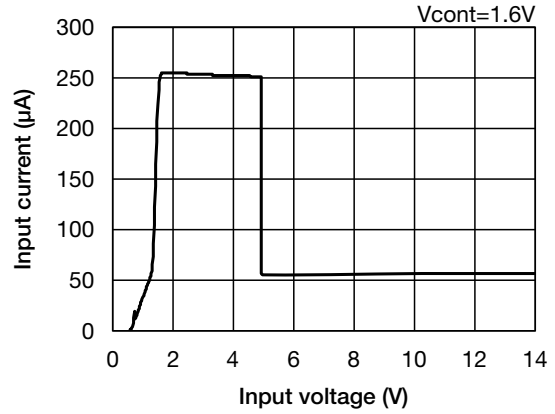

■ Cont pin voltage - Input current

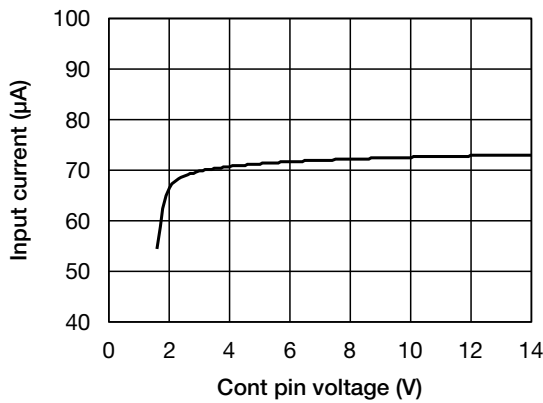

■ Input voltage - Output voltage

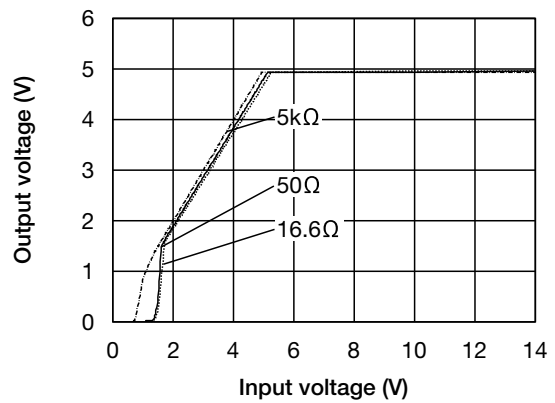

■ Line regulation

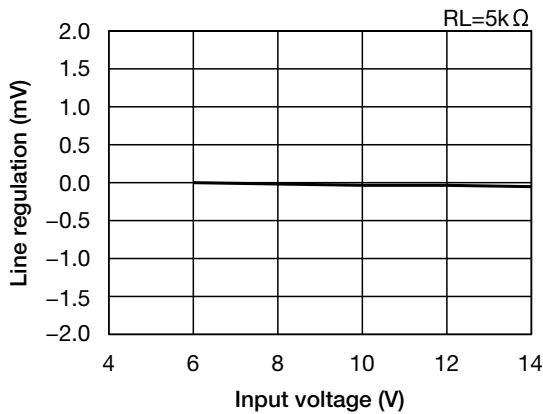

■ Load regulation

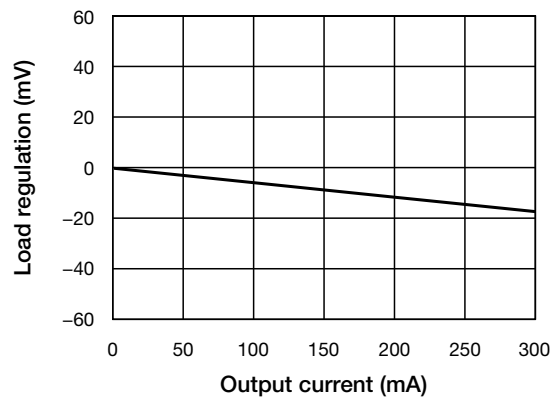

■ Cont pin voltage - Cont pin current

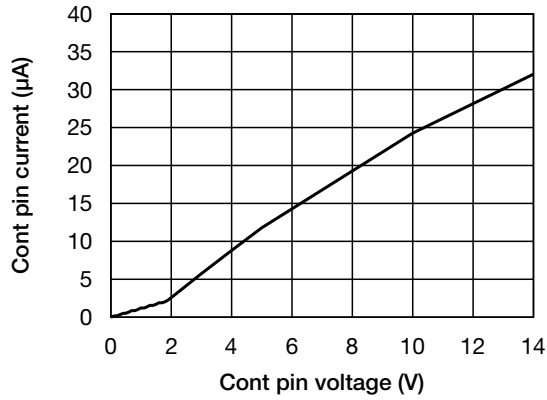

■ Dropout voltage

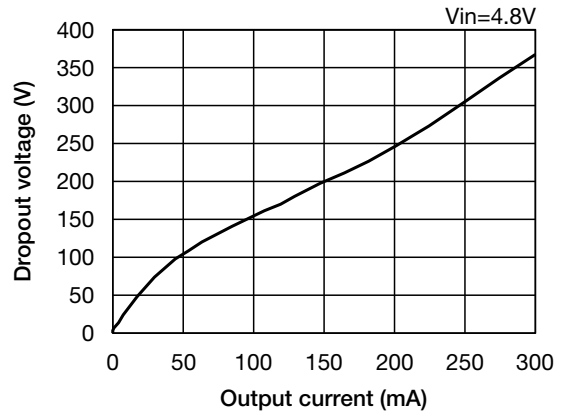

■ Ambient Temperature - Output voltage

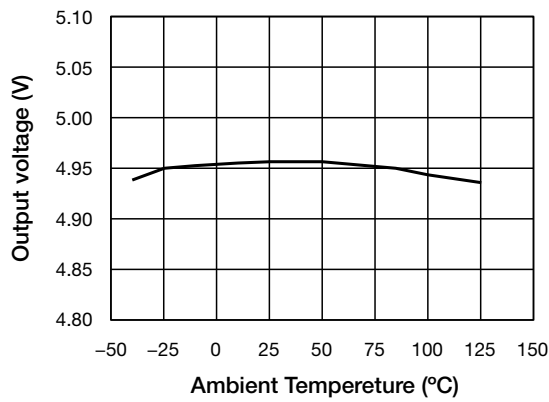

■ Thermal Shut Down

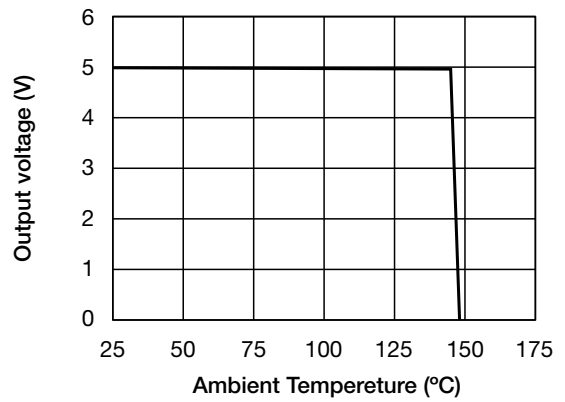

■ Ripple Rejection

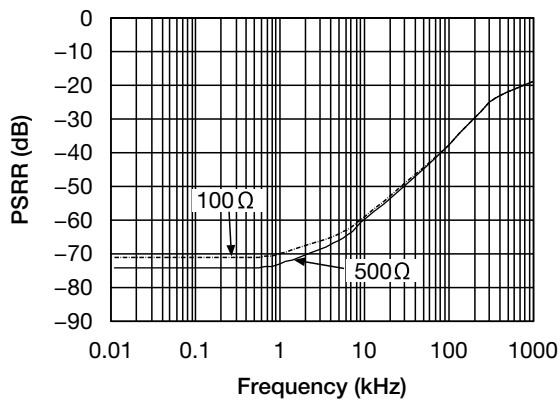

■ Turn-On Transient response

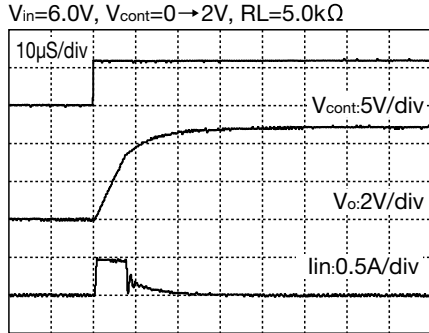

■ Turn-Off Transient response

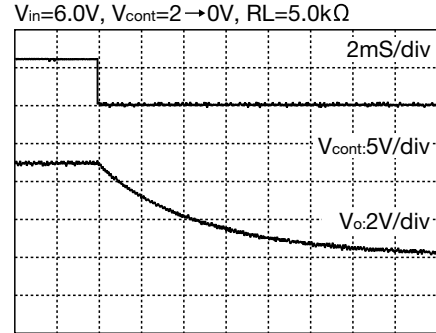

■ Load Transient response

