

Composite Regulator Monolithic IC MM1448

Outline

This IC was developed as a composite power supply for the RF section of mobile telephones. It is composed of three normal voltage regulator circuits, of which the output of one circuit is divided for two switching circuits.

The regulator output voltage is fixed, and each can be set between 2.0V and 5.0V according to the customer's needs. Output noise voltage noise reduction is made possible by using the noise reduction pin.

Also, switch pins are provided to control each output, making this an ideal IC for use in portable equipment.

Features

- | | |
|------------------------------------|--|
| 1. Input/output voltage difference | Vo1 : 0.2V max. Vo2 : 0.2V max. Vo3 : 0.3V max. |
| 2. Output noise voltage | Vo1 : 30μVrms typ. Vo2 : 30μVrms typ. Vo3 : 30μVrms typ. |
| 3. Output voltage precision | Vo1, Vo2, Vo3 : ±3% |
| 4. No-load input current | Vo1 : 170μA typ. Vo2 : 170μA typ. Vo3 : 170μA typ. |
| 5. Input voltage | 12V max. |
| 6. Max. output current | 200mA max. |
| 7. Output ON/OFF control | High : ON, Low : OFF |

Rank Table

Rank	Regulator Output Voltage		
	Vo1	Vo2	Vo3
X	2.5 ± 0.08	2.8 ± 0.08	3.0 ± 0.08
B	2.8 ± 0.08	2.8 ± 0.08	3.0 ± 0.08
C	2.9 ± 0.08	2.9 ± 0.08	2.9 ± 0.08

Package

VSOP-16

Applications

1. Mobile telephones, PHS
2. Video cameras
3. Portable communication equipment
4. Battery-powered portable equipment

Pin Assignment

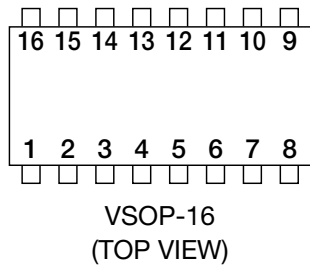

1	Vo1	9	Vo2
2	NS1	10	GND
3	PS1	11	PS4
4	V _{IN}	12	Vo4
5	PS3	13	NC
6	NS3	14	Vo5
7	PS2	15	PS5
8	NS2	16	Vo3

Equivalent Circuit Diagram

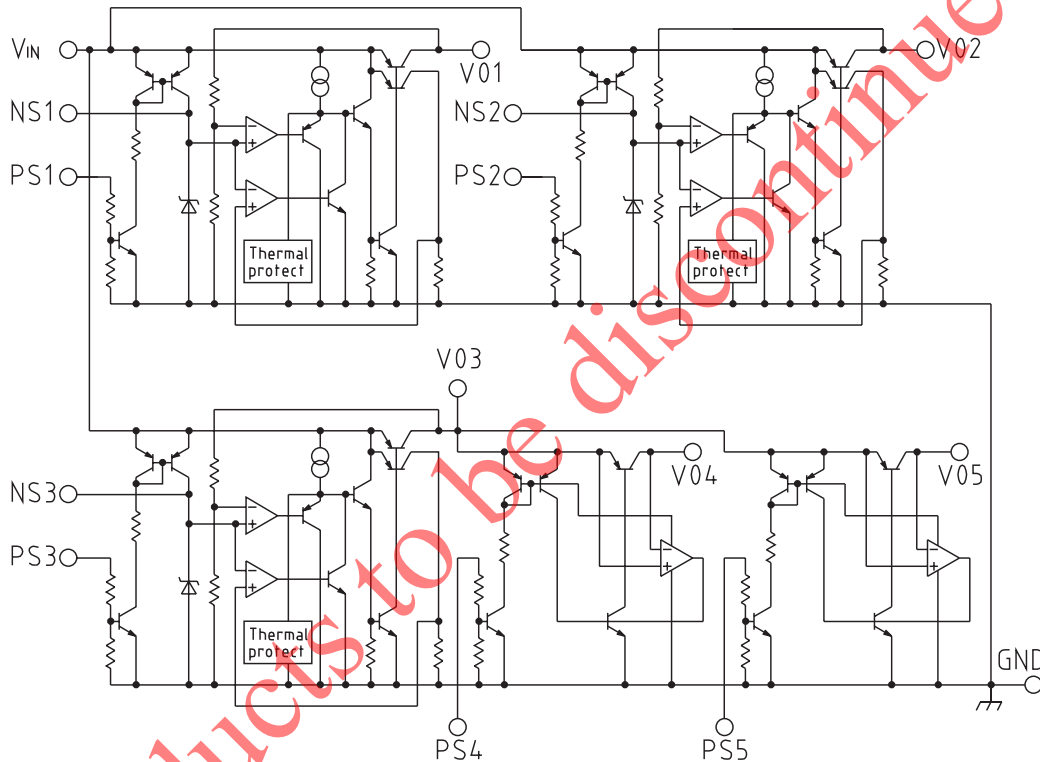

Absolute Maximum Ratings

Item	Symbol	Rating	Unit
Storage Temperature	T _{STG}	-40~+125	°C
Operating Temperature	T _{OPR}	-20~+75	°C
Power Supply Voltage	V _{IN}	-0.3~+12	V
Output Current (1 circuit)	I _{O (m)}	200	mA
Power Consumption	P _d	400 (IC only)	mW

Recommended Operating Conditions

Item	Symbol	Rating	Unit
Operating Temperature	T _{OP}	-20~75	°C
Operating Voltage	V _{OP}	1.8~12	V
Regulator Output Current (1 circuit)	I _{O (m)}	0~100	mA

Electrical Characteristics Typical model : MM1448B (Except where noted otherwise, Ta=25°C, VIN=4V, CIN=10μF, Cvo(n)=4.7μF+1Ω, Cns(n)=0.01μF)

Item	Symbol	Measurement conditions	Min.	Typ.	Max.	Unit
Standby current	I _{ins}	V _{PS1} =V _{PS2} =V _{PS3} =0V		0	3	μA
Operating currents 1~3 (for 1 circuit; all 3 circuits the same)	I _{IN1-3}	No-load (unload)		170	350	μA
		V _{PS1} =3V, V _{PS2} =V _{PS3} =V _{PS4} ~V _{PS5} =0V				
		V _{PS2} =3V, V _{PS1} =V _{PS3} =V _{PS4} ~V _{PS5} =0V				
		V _{PS3} =3V, V _{PS1} =V _{PS2} =V _{PS4} ~V _{PS5} =0V				
Vo1						
Output voltage	V _{o1}	I _{o1} =30mA	2.72	2.80	2.88	V
Minimum input/ output voltage difference	V _{dmin1}	V _{IN} =2.6V, I _{o1} =30mA			0.20	V
Load fluctuation	ΔV _{Lo1}	I _{o1} =0~100mA			60	mV
Input fluctuation	ΔV _{Li1}	V _{IN} =4.0~8.0V, I _{o1} =30mA			20	mV
Output voltage temperature coefficient	ΔV _{o1} /ΔT	T _j =-20~75°C, I _{o1} =30mA		±100		ppm/°C
Ripple rejection rate	RR1	f=120Hz, V _{RIPPLE} =1V _{P-P} , I _{o1} =30mA	50	60		dB
Output noise voltage	V _{n1}	f=10Hz~10kHz, I _{o1} =30mA, C _{ns1} =0.01μF		30	60	μV _{rms}
Output rise time	T _{dH1}	I _{o1} =30mA, V _{PS1} =0 → 4V		0.04	0.8	ms
Vo2						
Output voltage	V _{o2}	I _{o2} =30mA	2.72	2.80	2.88	V
Minimum input/ output voltage difference	V _{dmin2}	V _{IN} =2.6V, I _{o2} =30mA			0.20	V
Load fluctuation	ΔV _{Lo2}	I _{o2} =0~100mA			60	mV
Input fluctuation	ΔV _{Li2}	V _{IN} =4.0~8.0V, I _{o2} =30mA			20	mV
Output voltage temperature coefficient	ΔV _{o2} /ΔT	T _j =-20~75°C, I _{o2} =30mA		±100		ppm/°C
Ripple rejection rate	RR2	f=120Hz, V _{RIPPLE} =1V _{P-P} , I _{o2} =30mA	50	60		dB
Output noise voltage	V _{n2}	f=10Hz~10kHz, I _{o2} =30mA, C _{ns2} =0.01μF		30	60	μV _{rms}
Output rise time	T _{dH2}	I _{o2} =30mA, V _{PS2} =0 → 4V		0.04	0.8	ms
Vo3						
Output voltage	V _{o3}	I _{o3} =30mA	2.92	3.00	3.08	V
Minimum input/ output voltage difference	V _{dmin3}	V _{IN} =2.8V, I _{o3} =30mA			0.20	V
Load fluctuation	ΔV _{Lo3}	I _{o3} =0~100mA			60	mV
Input fluctuation	ΔV _{Li3}	V _{IN} =4.0~8.0V, I _{o3} =30mA			20	mV
Output voltage temperature coefficient	ΔV _{o3} /ΔT	T _j =-20~75°C, I _{o3} =30mA		±100		ppm/°C
Ripple rejection rate	RR3	f=120Hz, V _{RIPPLE} =1V _{P-P} , I _{o3} =30mA	50	60		dB
Output noise voltage	V _{n3}	f=10Hz~10kHz, I _{o3} =30mA, C _{ns3} =0.01μF		30	60	μV _{rms}
Output rise time	T _{dH3}	I _{o3} =30mA, V _{PS3} =0 → 4V		0.04	0.8	ms
Vo4						
Output voltage	V _{o4}	I _{o3} =I _{o4} =20mA, I _{o5} =40mA	2.82		V _{o3}	V
Output current	I _{o4}	V _{o4} =2.72V, I _{o3} =I _{o5} =0mA	50			mA
Output rise time	T _{dH4}	I _{o4} =20mA, C _{vo4} =1μF, V _{PS4} =0 → 4V		0.02	0.1	ms
Reactive current	I _{q4}	I _{o4} =20mA, V _{o3} =3V		0.5	0.8	mA
Vo5						
Output voltage	V _{o5}	I _{o3} =I _{o4} =20mA, I _{o5} =40mA	2.82		V _{o3}	V
Output current capacity	I _{o5}	V _{o5} =2.72V, I _{o3} =I _{o4} =0mA	80			mA
Output rise time	T _{dH5}	I _{o5} =40mA, C _{out5} =1μF, V _{PS5} =0 → 4V		0.02	0.1	ms
Reactive current	I _{q5}	I _{o5} =40mA, V _{o3} =3V		2	2.8	mA
PS output control pin						
Psn pin OFF voltage	V _{OFF}				0.4	V
Psn pin ON voltage	V _{ON}		1.6			V
Psn pin inflow current	I _{PSN}	V _{PSN} =1.6V			10	μA

Measurement Circuit

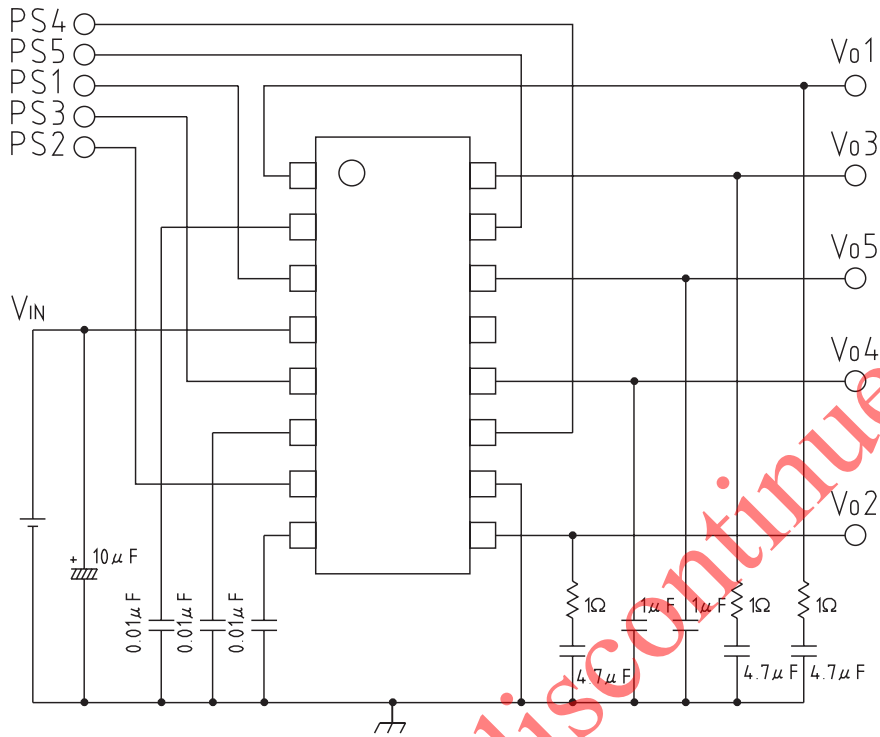

- Note 1: Output capacitance definitely is required to perform regulator and switch phase compensation. Also, please note that oscillation may occur depending on the ESR value.
- Note 2: Vo pin output noise voltage is reduced using NS pin capacitance value. Even if there is no need to take output noise voltage into consideration, connection of a capacitor is recommended for stable operation and improvement of AC characteristics.
- Note 3: The cause of oscillation is due to set wiring and capacitance changes in capacitor caused by temperatures changes, so please take extra care in placing the wires.

Characteristics

■ Input-Output Differential Voltage

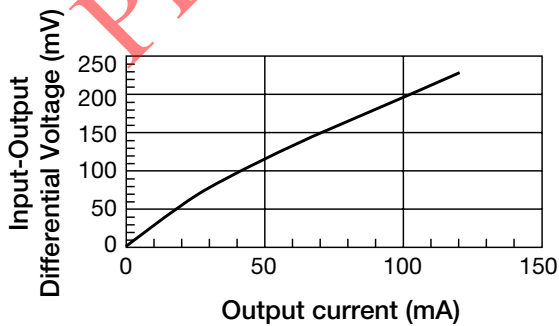

■ Line Regulation

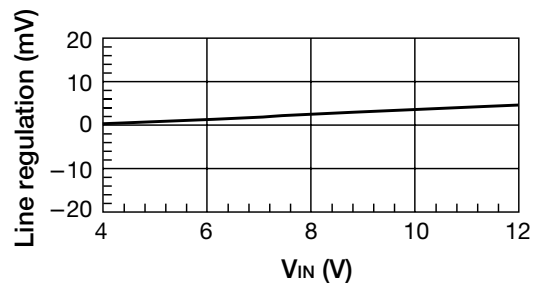

■ Load Regulation

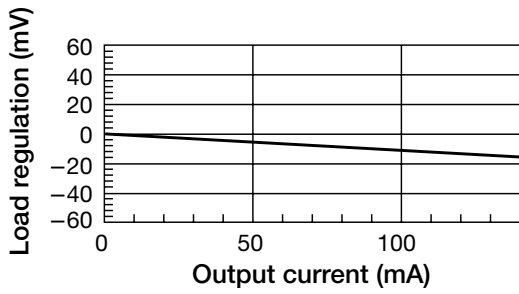

■ Thermal Shutdown

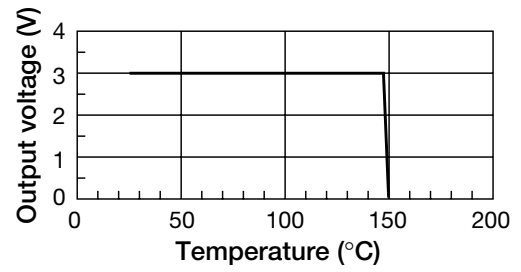

■ Output Current

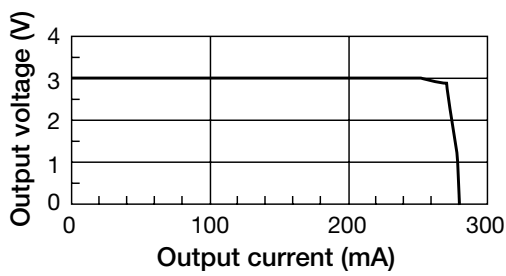

■ ESR Stable Region

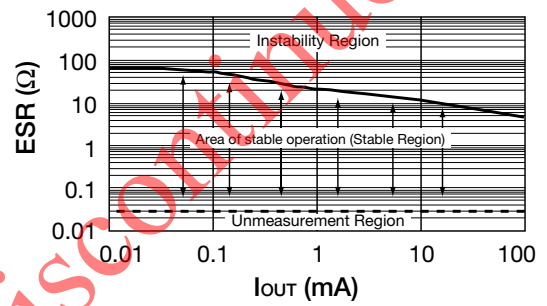

Note: Reference data

■ Io4 (5) – ΔVo34 (35)(Vo3=3V)

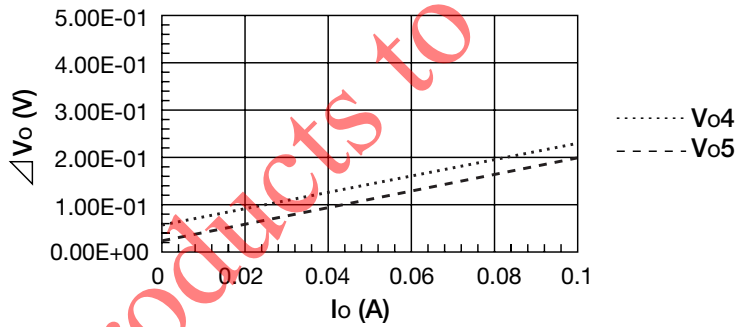

■ Io4 (5) – Iq4 (5)(Vo3=3V)

