

High Precision Operational Amplifier Monolithic IC MM6558 Series

Outline

This IC is a high precision operational amplifier, which is pin compatible with general use operational amplifier 4558, and has greatly improved input offset voltage and drift voltage. The offset is much smaller than for a general use operational amplifier, so offset adjustment is not needed. This contributes to reduction in the number of processes. Also, drift relative to stress is greatly reduced, so there is much less effect of stress due to IC strain and the like.

Features

	Power supply	Low input offset voltage	Low input offset drift	Power consumption	Through rate	Input conversion noise voltage
MM6558	±Power supply	0.1mV typ.	±1μV/°C typ.	3.00mA typ.	3V/μS typ.	1.2μVrms typ.
MM6559		0.1mV typ.	±1μV/°C typ.	3.00mA typ.	3V/μS typ.	1.2μVrms typ.
MM6560		0.1mV typ.	±1μV/°C typ.	3.50mA typ.	3V/μS typ.	1.2μVrms typ.
MM6561		0.1mV typ.	±1μV/°C typ.	1.70mA typ.	3V/μS typ.	1.2μVrms typ.
MM6572		0.1mV typ.	±1μV/°C typ.	3.50mA typ.	6V/μS typ.	0.5μVrms typ.
MM6564	Single-phase power supply	0.2mV typ.	±2μV/°C typ.	0.35mA typ.	1V/μS typ.	1.8μVrms typ.
MM6565		0.2mV typ.	±2μV/°C typ.	0.35mA typ.	1V/μS typ.	2.0μVrms typ.

Package

1. SOP-8C, SOP-8E (MM65□□XF)
2. DIP-8B (MM65□□XD)
3. SIP-8A (MM65□□XS)

Applications

1. Office automation equipment
2. measurement equipment
3. sensor equipment

MM6558

Absolute Maximum Ratings (Ta=25°C)

Item	Symbol	Rating	Units
Storage temperature	T _{STG}	-40~+125	°C
Operating temperature	T _{OPR}	-20~+75	°C
Power supply voltage	V ⁺ /V ⁻	±12	V
Allowable power dissipation	P _d	300	mW
Differential input voltage	V _{ID}	±20	V
Input voltage	V _I	±10	V

Electrical Characteristics (Unless otherwise specified Ta=25°C, V⁺/V⁻=±10V)

Item	Symbol	Measurement Conditions	Min.	Typ.	Max.	Units
Operating power supply voltage range			±3.5		±11	V
Input offset voltage	V _{IO}	R _S ≤ 10kΩ		0.1	0.5	mV
Input offset voltage temperature drift	ΔV _{IO}			±1		μV/°C
Input offset current	I _{IO}			5	200	nA
Input bias current	I _B			50	500	nA
Input resistance	R _{IN}		0.3	3		MΩ
In-phase input voltage	V _{CM}		±8	±9		V
Voltage gain	A _v	R _L ≥ 2kΩ, V _O =±7V	86	100		dB
Maximum output voltage	V _O	R _L ≥ 10kΩ	±8	±9		V
In-phase signal elimination ratio	CMRR	R _S ≤ 10kΩ	70	90		dB
Power supply voltage elimination ratio	PSRR	R _S ≤ 10kΩ	76.5	90		dB
Current consumption	I _{CC}			3.0	5.0	mA
Output flow current	I _{SO}		13			mA
Output inflow current	I _{SI}		13			mA
Through rate	SR	R _L ≥ 2kΩ		3		V/μs
Gain band area	GBW			7		MHz
Input conversion interference voltage	e _n	R _S =300Ω, IHFA (A curve)		1.2		μV _{rms}

MM6559

Absolute Maximum Ratings (Ta=25°C)

Item	Symbol	Rating	Units
Storage temperature	T _{STG}	-40~+125	°C
Operating temperature	T _{OPR}	-20~+75	°C
Power supply voltage	V ⁺ /V ⁻	±12	V
Allowable power dissipation	P _d	300	mW
Differential input voltage	V _{ID}	±20	V
Input voltage	V _I	±10	V

Electrical Characteristics (Unless otherwise specified Ta=25°C, V⁺/V⁻=±10V)

Item	Symbol	Measurement Conditions	Min.	Typ.	Max.	Units
Operating power supply voltage range			±2		±11	V
Input offset voltage	V _{IO}	R _S ≤ 10kΩ		0.1	0.5	mV
Input offset voltage temperature drift	ΔV _{IO}			±1		μV/°C
Input offset current	I _{IO}			5	200	nA
Input bias current	I _B			50	500	nA
Input resistance	R _{IN}		0.3	3		MΩ
In-phase input voltage	V _{CM}		±8	±9		V
Voltage gain	A _v	R _L ≥ 2kΩ, V _O =±7V	86	100		dB
Maximum output voltage	V _O	R _L ≥ 10kΩ	±8	±9		V
In-phase signal elimination ratio	CMRR	R _S ≤ 10kΩ	70	90		dB
Power supply voltage elimination ratio	PSRR	R _S ≤ 10kΩ	76.5	90		dB
Current consumption	I _{CC}			3.0	5.0	mA
Output flow current	I _{SO}		13			mA
Output inflow current	I _{SI}		13			mA
Through rate	SR	R _L ≥ 2kΩ		3		V/μs
Gain band area	GBW			7		MHz
Input conversion interference voltage	e _n	R _S =300Ω, IHFA (Acurve)		1.2		μV _{rms}

MM6560

Absolute Maximum Ratings (Ta=25°C)

Item	Symbol	Rating	Units
Storage temperature	T _{STG}	-40~+125	°C
Operating temperature	T _{OPR}	-20~+75	°C
Power supply voltage	V ⁺ /V ⁻	±12	V
Allowable power dissipation	P _d	300	mW
Differential input voltage	V _{ID}	±20	V
Input voltage	V _I	±10	V

Electrical Characteristics (Unless otherwise specified Ta=25°C, V⁺/V⁻=±10V)

Item	Symbol	Measurement Conditions	Min.	Typ.	Max.	Units
Operating power supply voltage range			±3.5		±11	V
Input offset voltage	V _{IO}	R _S ≤ 10kΩ		0.1	0.5	mV
Input offset voltage temperature drift	ΔV _{IO}			±1		μV/°C
Input offset current	I _{IO}			5	200	nA
Input bias current	I _B			50	500	nA
Input resistance	R _{IN}		0.3	3		MΩ
In-phase input voltage	V _{CM}		±8	±9		V
Voltage gain	A _v	R _L ≥ 2kΩ, V _O =±7V	86	100		dB
Maximum output voltage	V _O	R _L ≥ 2kΩ	±8	±9		V
In-phase signal elimination ratio	CMRR	R _S ≤ 10kΩ	70	90		dB
Power supply voltage elimination ratio	PSRR	R _S ≤ 10kΩ	76.5	90		dB
Current consumption	I _{CC}			3.5	5.7	mA
Output flow current	I _{SO}		25			mA
Output inflow current	I _{SI}		25			mA
Through rate	SR	R _L ≥ 2kΩ		3		V/μs
Gain band area	GBW			7		MHz
Input conversion interference voltage	e _n	R _S =300Ω, IHFA (A curve)		1.2		μV _{rms}

MM6561

Absolute Maximum Ratings (Ta=25°C)

Item	Symbol	Rating	Units
Storage temperature	T _{STG}	-40~+125	°C
Operating temperature	T _{OPR}	-20~+75	°C
Power supply voltage	V ⁺ /V ⁻	±12	V
Allowable power dissipation	P _d	300	mW
Differential input voltage	V _{ID}	±20	V
Input voltage	V _I	±10	V

Electrical Characteristics (Unless otherwise specified Ta=25°C, V⁺/V⁻=±10V)

Item	Symbol	Measurement Conditions	Min.	Typ.	Max.	Units
Operating power supply voltage range			±3.5		±11	V
Input offset voltage	V _{IO}	R _S ≤ 10kΩ		0.1	0.5	mV
Input offset voltage temperature drift	ΔV _{IO}			±1		μV/°C
Input offset current	I _{IO}			5	200	nA
Input bias current	I _B			50	500	nA
Input resistance	R _{IN}		0.3	3		MΩ
In-phase input voltage	V _{CM}		±8	±9		V
Voltage gain	A _v	R _L ≥ 5kΩ, V _O =±7V	86	100		dB
Maximum output voltage	V _O	R _L ≥ 10kΩ	±8	±9		V
In-phase signal elimination ratio	CMRR	R _S ≤ 10kΩ	70	90		dB
Power supply voltage elimination ratio	PSRR	R _S ≤ 10kΩ	76.5	90		dB
Current consumption	I _{CC}			1.7	2.7	mA
Output flow current	I _{SO}		6			mA
Output inflow current	I _{SI}		6			mA
Through rate	SR	R _L ≥ 2kΩ		3		V/μs
Gain band area	GBW			7		MHz
Input conversion interference voltage	e _n	R _S =300Ω, IHFA (A curve)		1.2		μV _{rms}

MM6572

Absolute Maximum Ratings (Ta=25°C)

Item	Symbol	Rating	Units
Storage temperature	T _{STG}	-40~+125	°C
Operating temperature	T _{OPR}	-20~+75	°C
Power supply voltage	V ⁺ /V ⁻	±12	V
Allowable power dissipation	P _d	300	mW
Differential input voltage	V _{ID}	±20	V
Input voltage	V _I	±10	V

Electrical Characteristics (Unless otherwise specified Ta=25°C, V⁺/V⁻=±10V)

Item	Symbol	Measurement Conditions	Min.	Typ.	Max.	Units
Operating power supply voltage range			±2		±11	V
Input offset voltage	V _{IO}	R _S ≤ 10kΩ		0.1	0.5	mV
Input offset voltage temperature drift	ΔV _{IO}			±1		μV/°C
Input offset current	I _{IO}			10	100	nA
Input bias current	I _B			200	500	nA
Input resistance	R _{IN}		100	260		kΩ
In-phase input voltage	V _{CM}		±8	±9		V
Voltage gain	A _v	R _L ≥ 2kΩ, V _O =±7V	86	100		dB
Maximum output voltage	V _O	R _L ≥ 10kΩ	±8	±9		V
In-phase signal elimination ratio	CMRR	R _S ≤ 10kΩ	70	90		dB
Power supply voltage elimination ratio	PSRR	R _S ≤ 10kΩ	76.5	90		dB
Current consumption	I _{CC}			3.5	5.0	mA
Output flow current	I _{SO}		13			mA
Output inflow current	I _{SI}		13			mA
Through rate	SR	R _L ≥ 2kΩ		6		V/μs
Gain band area	GBW			10		MHz
Input conversion interference voltage	e _n	R _S =300Ω, IHFA (A curve)		0.5		μV _{rms}

MM6564

Absolute Maximum Ratings (Ta=25°C)

Item	Symbol	Rating	Units
Storage temperature	T _{STG}	-40~+125	°C
Operating temperature	T _{OPR}	-20~+75	°C
Power supply voltage	V _{CC} max.	15	V
Allowable power dissipation	P _d	XF300 XD875	mW
Input voltage	V _I	0~15	V

Electrical Characteristics (Unless otherwise specified Ta=25°C, V_{CC}=3V, V_I=1V)

Item	Symbol	Measurement Conditions	Min.	Typ.	Max.	Units
Operating power supply voltage range			2	3	13	V
Input offset voltage	V _{IO}			0.2	0.9	mV
Input offset voltage temperature drift	ΔV _{IO}			±2		μV/°C
Input offset current	I _{IO}			5	30	nA
Input bias current	I _B			30	150	nA
Input voltage range	V _I		0		V _{CC} -1	V
Voltage gain	A _v	R _L ≥ 100kΩ	80	100		dB
Output voltage range	V _O		0.1		V _{CC} -1	V
Output flow current	I _{SO}		0.5			mA
In-phase signal elimination ratio	CMRR	R _S ≤ 10kΩ	70	90		dB
Power supply voltage elimination ratio	PSRR	R _S ≤ 10kΩ	76.5	90		dB
Current consumption	I _{CC}			0.35	0.5	mA
Through rate	SR			1		V/μs
Gain band area	GBW			2		MHz
Input conversion interference voltage	e _n	R _S =300Ω, IHFA (A curve)		1.8		μVrms

MM6565

Absolute Maximum Ratings (Ta=25°C)

Item	Symbol	Rating	Units
Storage temperature	T _{STG}	-40~+125	°C
Operating temperature	T _{OPR}	-20~+75	°C
Power supply voltage	V _{CC} max.	15	V
Allowable power dissipation	P _d	300	mW
Input voltage	V _I	0~15	V

Electrical Characteristics (Unless otherwise specified Ta=25°C, V_{CC}=5V)

Item	Symbol	Measurement Conditions	Min.	Typ.	Max.	Units
Operating power supply voltage range			4	5	13	V
Input offset voltage	V _{IO}			0.2	0.9	mV
Input offset voltage temperature drift	ΔV _{IO}			±2		μV/°C
Input offset current	I _{IO}			5	30	nA
Input bias current	I _B			30	150	nA
Input voltage range	V _I		0		V _{CC} -1	V
Voltage gain	A _V	R _L ≥ 100kΩ	80	100		dB
Output voltage range	V _O	R _L ≥ 10kΩ	GND±1		V _{CC} -1	V
Output flow current	I _{SO}		0.5			mA
Output inflow current	I _{SI}		0.5			mA
In-phase signal elimination ratio	CMRR	R _S ≤ 10kΩ	70	90		dB
Power supply voltage elimination ratio	PSRR	R _S ≤ 10kΩ	76.5	90		dB
Current consumption	I _{CC}			0.35	0.5	mA
Through rate	SR	R _L ≥ 10kΩ		1		V/μs
Gain band area	GBW			1		MHz
Input conversion interference voltage	e _n	R _S =300Ω, IHFA (A curve)		2.0		μV _{rms}

Pin Assignment

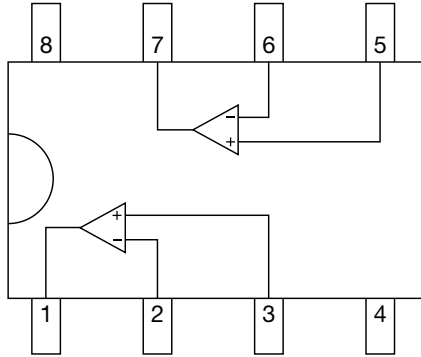

SOP-8C, SOP-8E (MM65□□XF)
 DIP-8B (MM65□□XD)
 SIP-8A (MM65□□XS)

Pin No..	Pin Function	
	MM6558 MM6559 MM6560 MM6561 MM6572	MM6564 MM6565
1	A _{OUT}	
2	A _{IN-}	
3	A _{IN+}	
4	V ₋	GND
5	B _{IN+}	
6	B _{IN-}	
7	B _{OUT}	
8	V ₊	V _{CC}

Characteristics

MM6558

Input conversion interference voltage vs signal source resistance

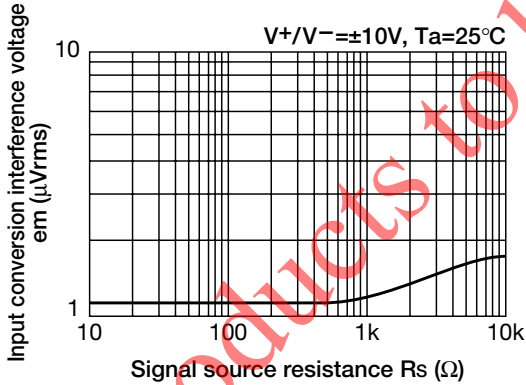

Input bias current vs power supply voltage

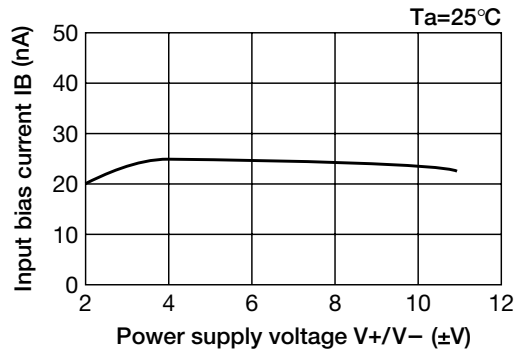

Input offset voltage vs power supply voltage

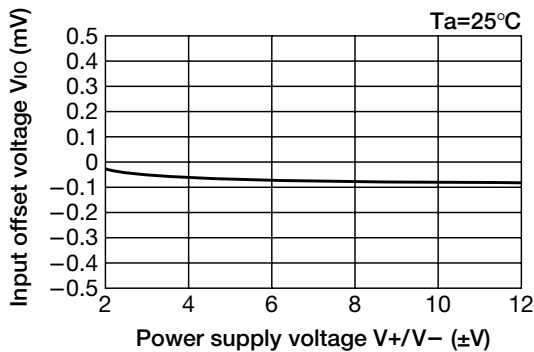

Current consumption vs power supply voltage

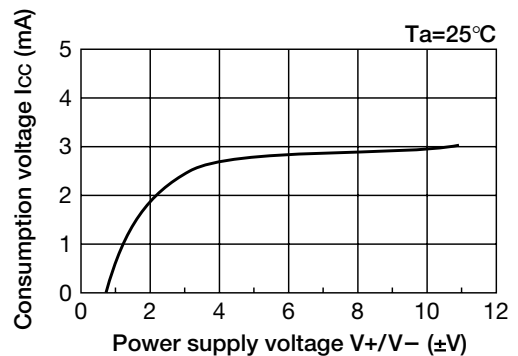

■ Input offset voltage vs power supply voltage

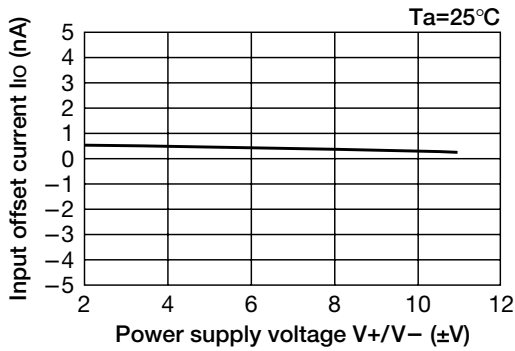

■ Complete higher harmonic distortion rate vs output voltage

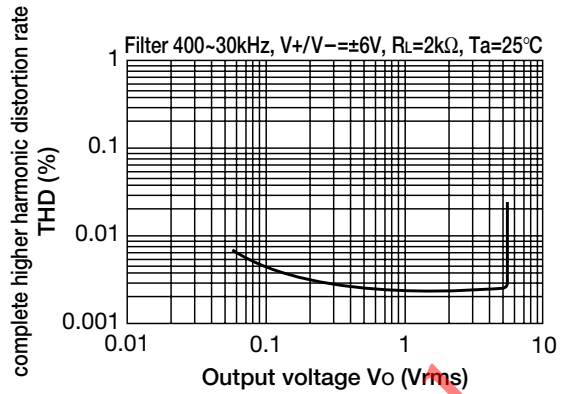

■ PSRR vs frequency

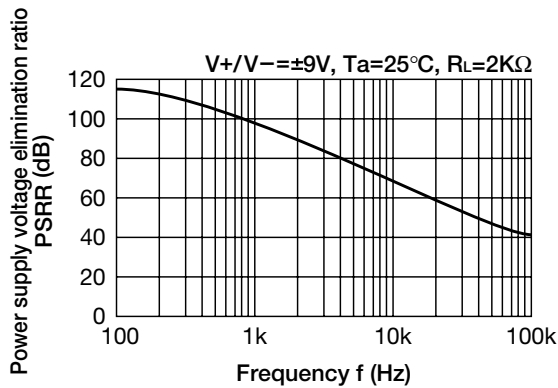

■ Maximum output voltage amplitude vs frequency

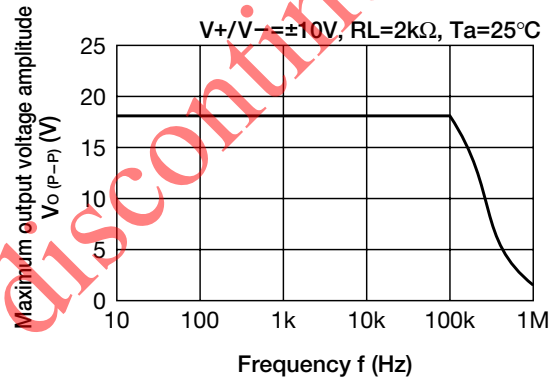

■ Maximum output voltage vs power supply voltage

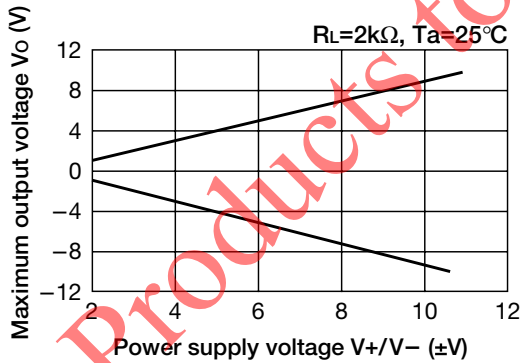

■ Voltage gain vs frequency

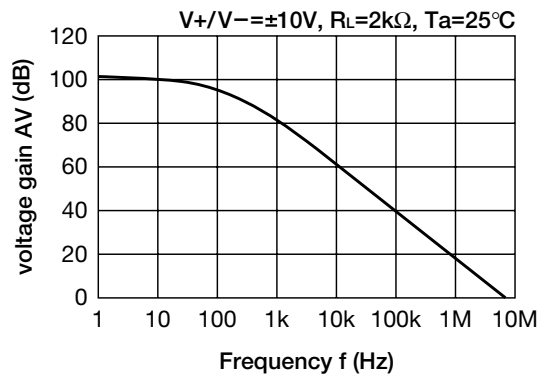

■ Maximum output voltage amplitude vs load

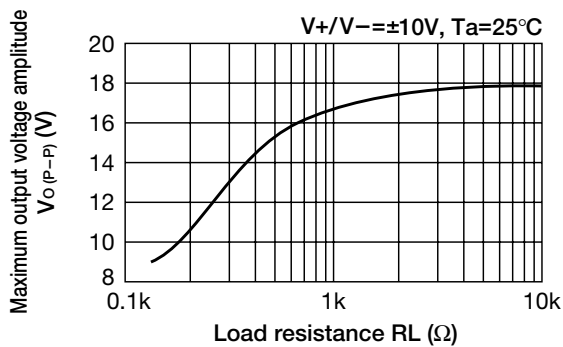

MM6559

■ Input offset voltage vs power supply voltage

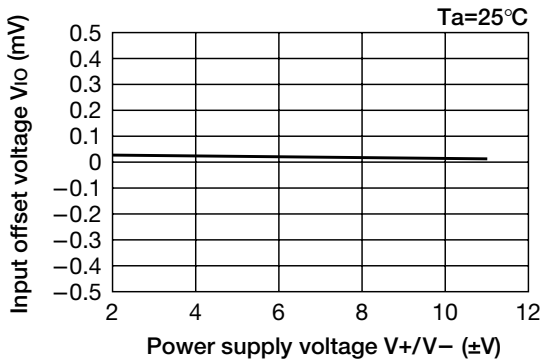

■ Current consumption vs power supply voltage

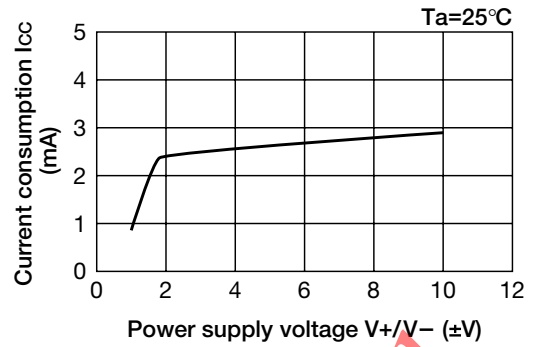

■ Input offset current vs power supply voltage

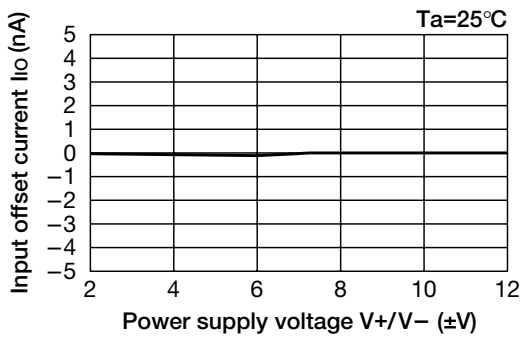

■ Maximum output voltage vs power supply voltage

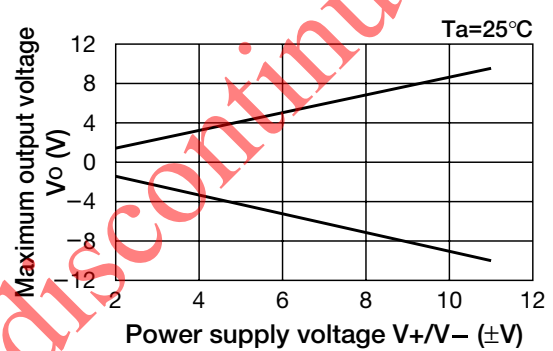

MM6560

■ Input offset voltage vs power supply voltage

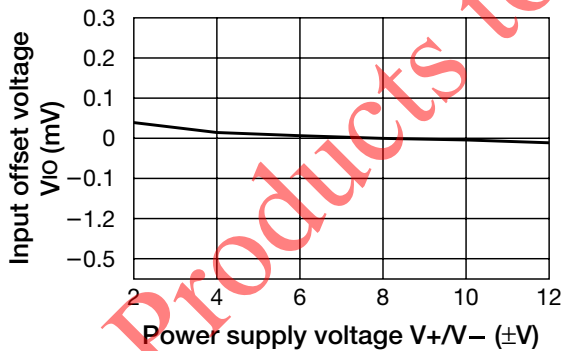

■ Current consumption vs power supply voltage

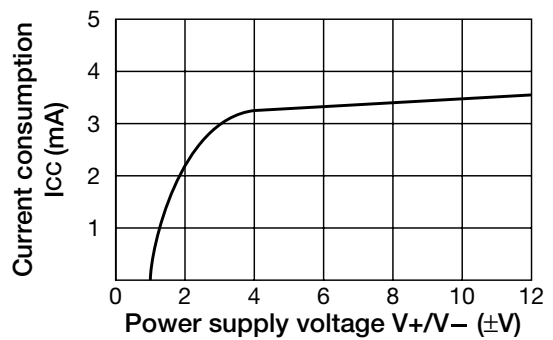

■ Input offset current vs power supply voltage

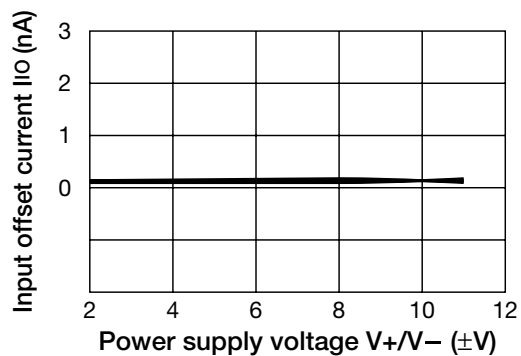

■ Maximum output voltage amplitude vs load

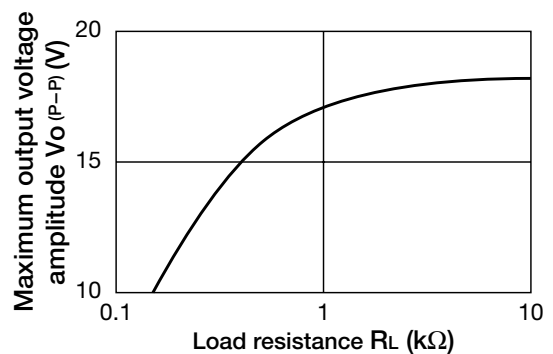

■ MM6561

■ Input offset voltage vs power supply voltage

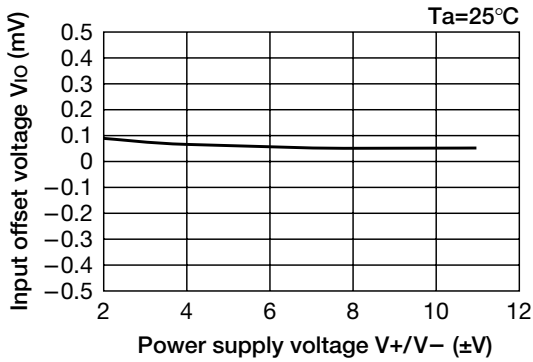

■ Current consumption vs power supply voltage

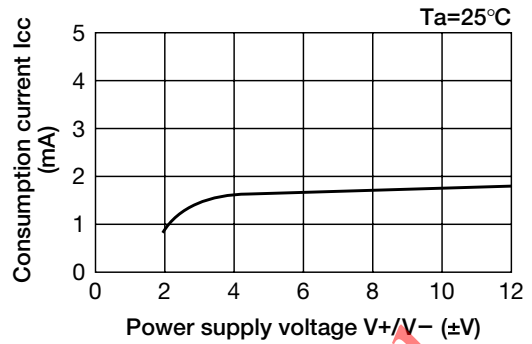

■ Input offset current vs power supply voltage

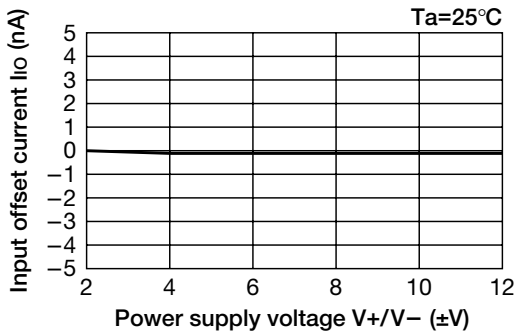

■ Maximum output voltage amplitude vs load

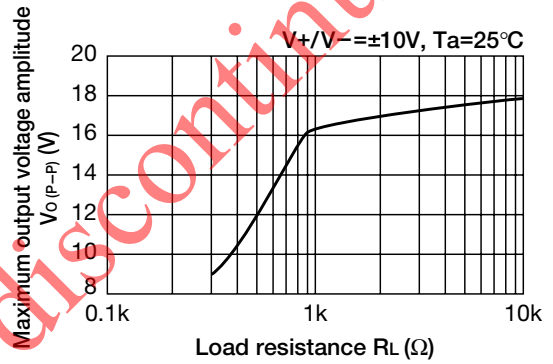

■ MM6572

■ Input offset voltage vs power supply voltage

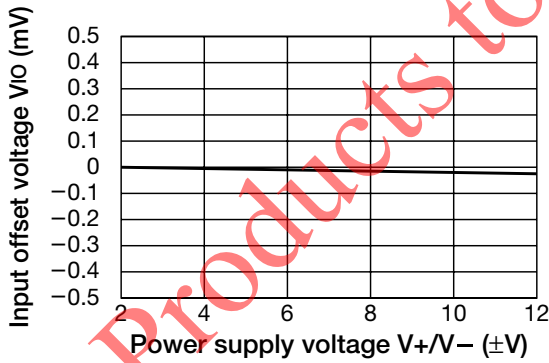

■ Current consumption vs power supply voltage

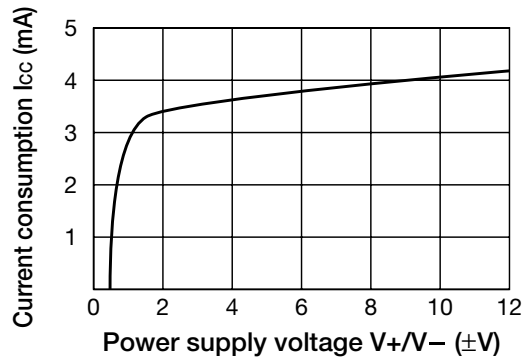

■ Input offset current vs power supply voltage

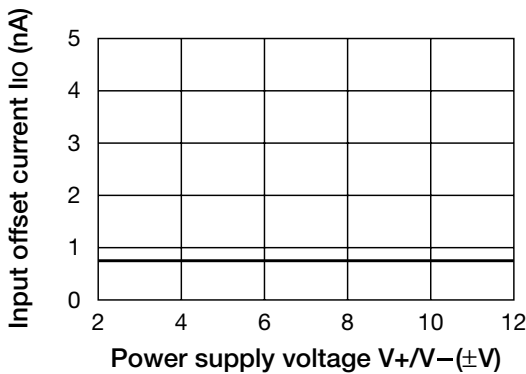

MM6564

Input conversion interference voltage vs signal source resistance

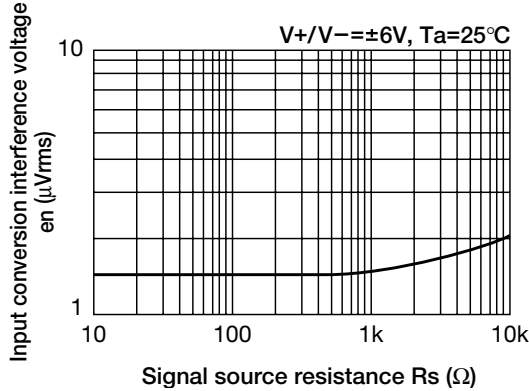

Input bias current vs power supply voltage

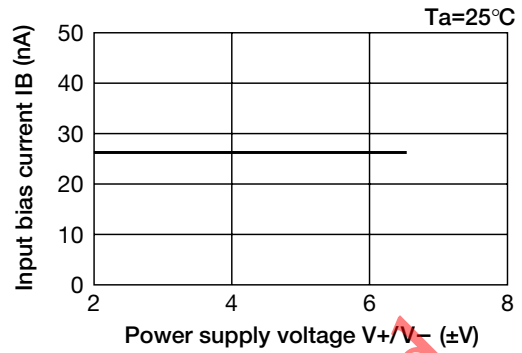

Input offset voltage vs power supply voltage

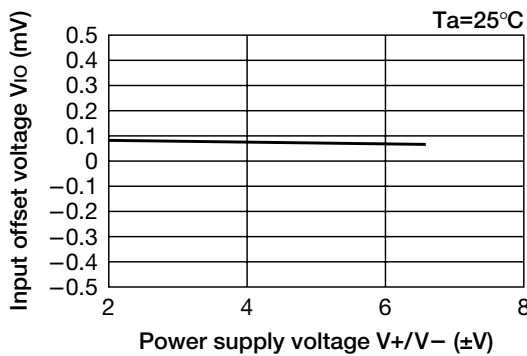

Input offset current vs power supply voltage

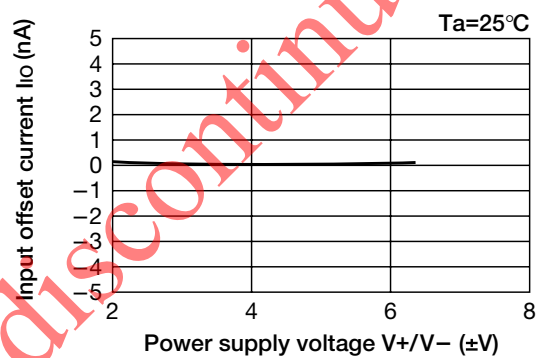

Complete higher harmonic distortion rate vs output voltage

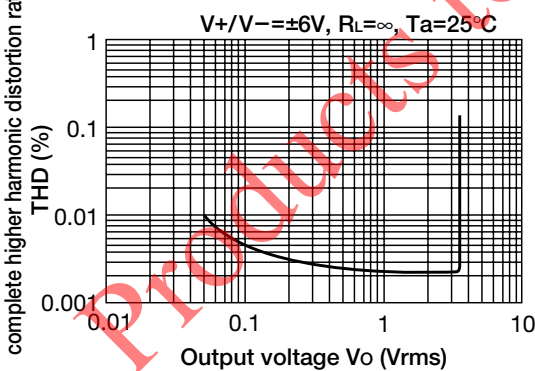

PSRR vs frequency

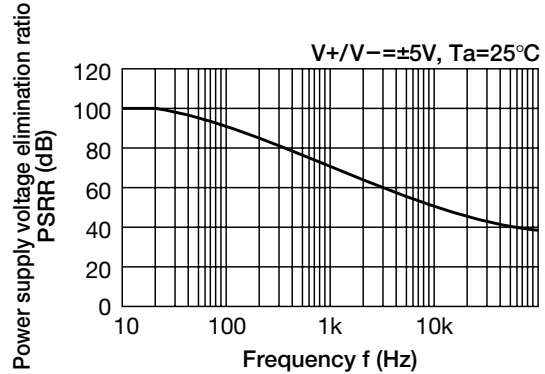

Maximum output voltage amplitude vs frequency

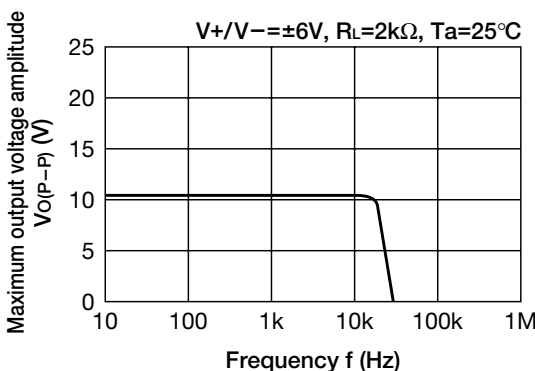

Maximum output voltage vs power supply voltage

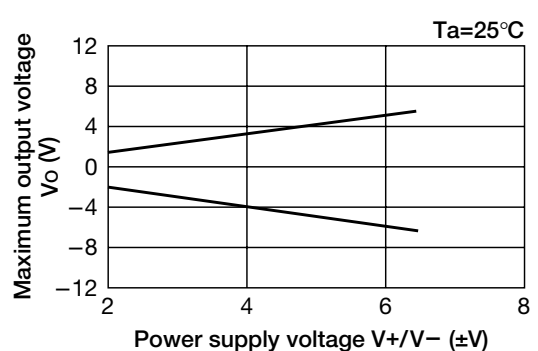

■ Voltage gain vs frequency

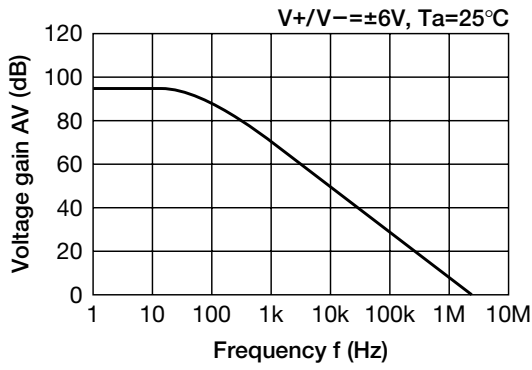

■ Current consumption vs power supply voltage

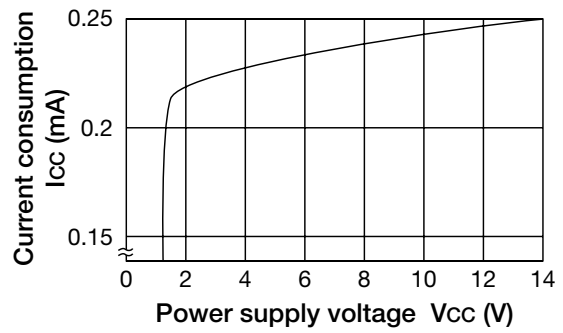

■ MM6565

■ Input conversion interference voltage vs signal source resistance

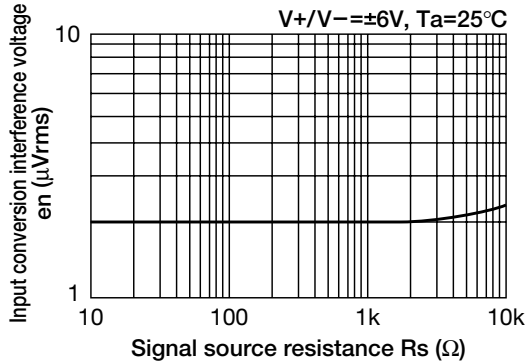

■ Current consumption vs power supply voltage

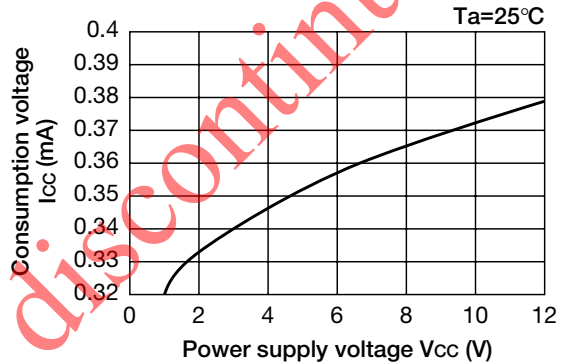

■ Input offset voltage vs power supply voltage

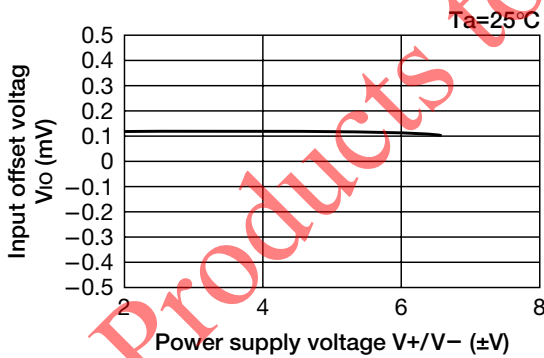

■ Complete higher harmonic distortion rate vs output voltage

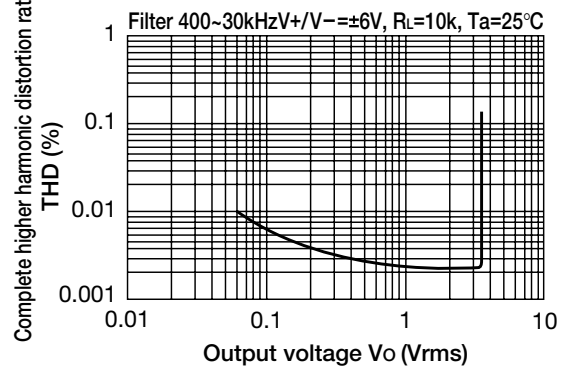

■ Input offset current vs power supply voltage

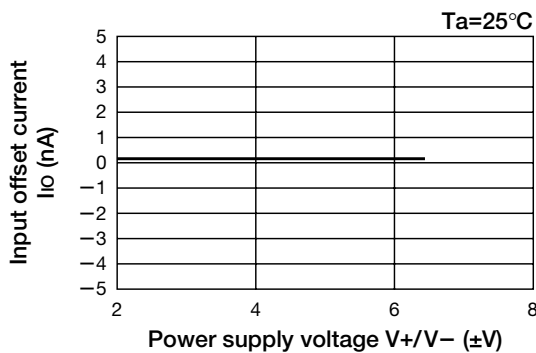

■ PSRR vs frequency

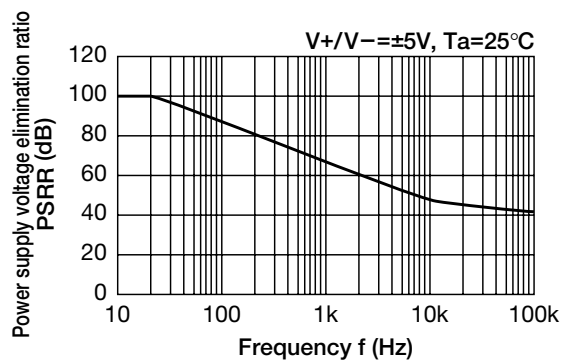

■ Maximum output voltage vs power supply voltage

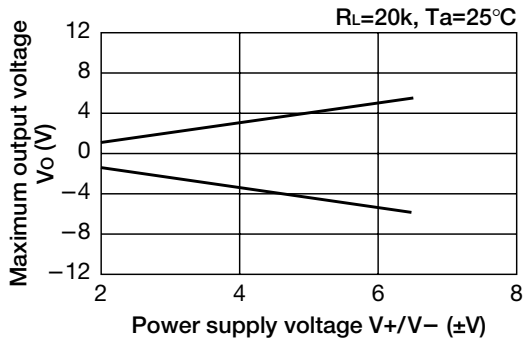

■ Maximum output voltage amplitude vs frequency

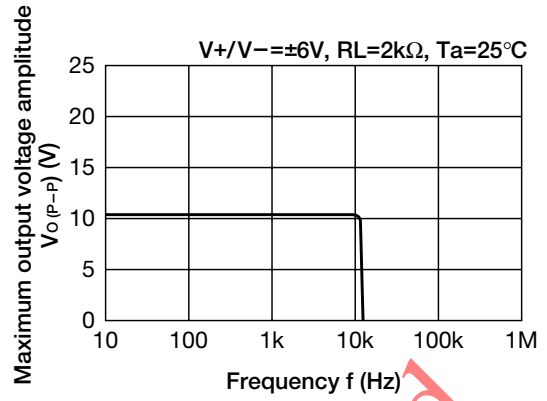

■ Maximum output voltage amplitude vs load

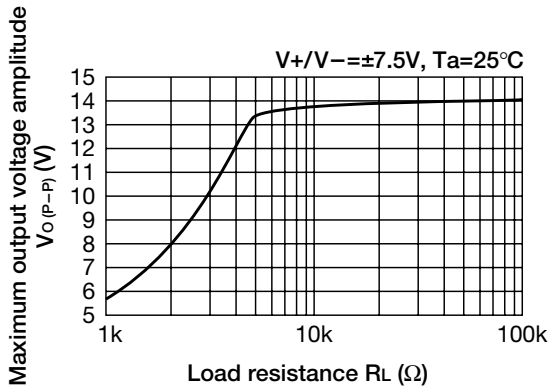

■ Voltage gain vs frequency

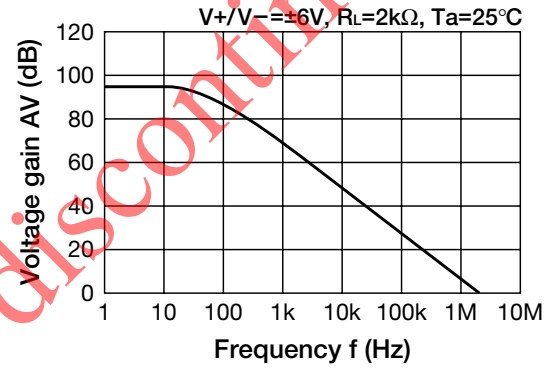

Products to be discontinued