

# Secondary-side Control for Energy-saving AC Adaptors Monolithic IC MM1529

## Outline

This IC is a secondary-side control IC for AC adaptors with energy-saving mode, and switches to energy-saving mode when there is no load current flowing to reduce power consumption in an AC adaptor. When a load current flows in normal mode, it enters to normal mode to power the load. To control the oscillator on the primary side, this IC controls two photocouplers, performs constant-voltage/constant-current control, and switches between energy-saving and normal modes.

## Features

1. Automatic switching between energy-saving mode and normal mode
2. Current consumption (energy-saving mode) 60µA
3. Current consumption (normal mode) 1.7mA
4. Reference voltage (internal/output inversion voltage) 1.250V±25mV
5. Controls the oscillator on the primary side using two photocouplers.
6. Photocouplers are use for constant-voltage/constant-current control and switching between energy-saving and normal modes.

## Package

SOP-8D

## Applications

1. AC adaptors (cell phones, movies, PDA, note PCs, and more)
2. Chargers (cell phones, movies, PDA, note PCs, and more)

## Pin Connetion Diagram

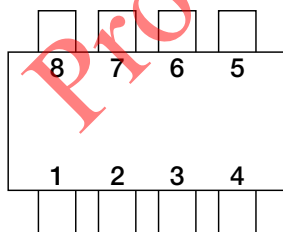

SOP-8D

1	PO1	5	REF
2	PO2	6	OUT
3	GND	7	CNT
4	CS	8	V <sub>CC</sub>

Block Diagram

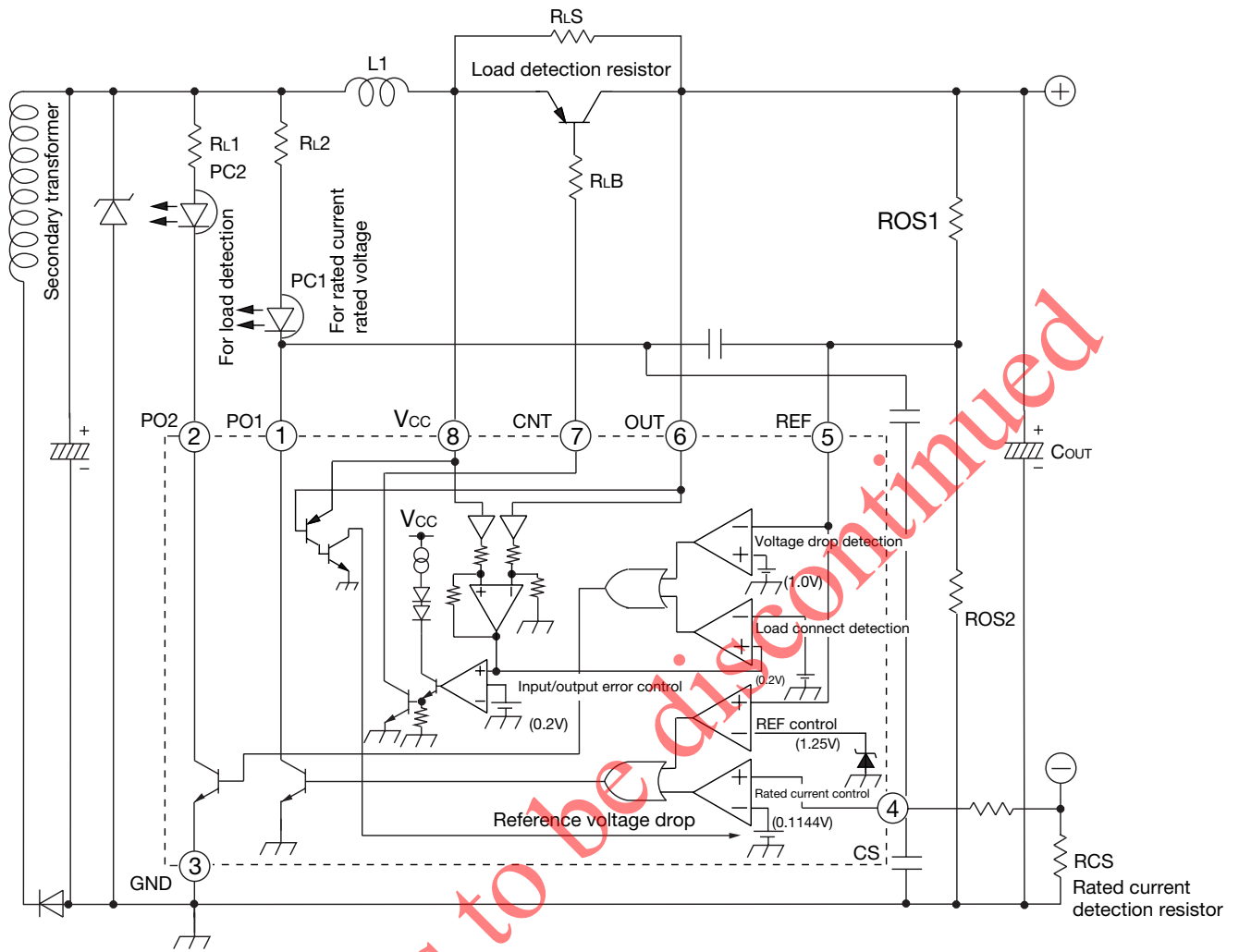

Terminal Explanation

Pin No.	Pin name	Function	Internal equivalent circuit
1	PO1	Rated current rated voltage control photocoupler LED drive pin. Connects cathode side of diode.	
2	PO2	Output load detection photocoupler LED drive pin. Connects cathode side of diode.	
3	GND	Ground pin.	
4	CS	Overcurrent detection pin. Doubles as output- pin. Connects overcurrent resistor to GND pin.	
5	REF	Reference voltage input pin. Connects Ros1 resistor to the OUT pin and Ros2 resistor to GND pin to control output pin. Output voltage= $\{1 + (Ros1 / Ros2)\} \times 1.25$	
6	OUT	Output +pin. Connects load detection resistor to Vcc pin and connects PNP power transistor collector.	
7	CNT	PNP power transistor control pin. Connects to PNP power transistor base.	
8	Vcc	+Power supply pin. Doubles as load detection pin. Connects load detection resistor to OUT pin and connects PNP power transistor emitter.	

Products to be discontinued

**Absolute Maximum Ratings** (Ta=25°C)

Item	Symbol	Rating	Unit
Storage temperature	T <sub>STG</sub>	-40~+125	°C
Operating temperature	T <sub>OPR</sub>	-30~+85	°C
Supply voltage	V <sub>CCmax.</sub>	-0.3~+18	V
Power dissipation	P <sub>D</sub>	300 (Alone)	mW

**Recommended Operating Conditions**

Item	Symbol	Rating	Unit
Operating temperature	T <sub>OPR</sub>	-30~+85	°C
Supply voltage	V <sub>OP</sub>	+2.5~+12	V

**Electrical Characteristics** (V<sub>CC</sub>=5.0V , Ta=25°C Unless otherwise specified)

Item	Symbol	Test Conditions	Min.	Typ.	Max.	Unit
Current consumption 1 (energy-saving mode)	I <sub>CC1</sub>	V <sub>OUT</sub> =5.0V V <sub>REF</sub> =1.2V V <sub>CS</sub> =0V		60	100	μA
Current consumption 2 (normal mode)	I <sub>CC2</sub>	V <sub>OUT</sub> =4.7V V <sub>REF</sub> =1.2V V <sub>CS</sub> =0V		1.7	3.5	mA
<b>Voltage control</b>						
Output inversion voltage	V <sub>REFH</sub>	V <sub>OUT</sub> =5.0V R <sub>L1</sub> =500Ω V <sub>REF</sub> :1.1V→H R <sub>L2</sub> =1kΩ V <sub>CS</sub> =0V R <sub>L3</sub> =100Ω	1.225	1.250	1.275	V
REF input voltage	I <sub>REF</sub>	V <sub>OUT</sub> =5.0V V <sub>REF</sub> =1.1V V <sub>CS</sub> =0V		15	100	nA
Power supply voltage removal	PSRR1	V <sub>CC</sub> =4V→12V V <sub>REF</sub> =1.5V V <sub>CS</sub> =0V R <sub>L1</sub> =5kΩ	60	70		dB
P01 output inflow current	I <sub>PO1-V</sub>	V <sub>OUT</sub> =5.0V V <sub>REF</sub> =1.5V V <sub>CS</sub> =0V V <sub>PO1</sub> =0.5V	5	17		mA

Item	Symbol	Test Conditions	Min.	Typ.	Max.	Unit
<b>Rated current control</b>						
Output inversion voltage 1 (rated current control)	V <sub>CS1</sub>	V <sub>OUT</sub> =4.7V R <sub>L1</sub> =500Ω V <sub>REF</sub> =1.2V R <sub>L2</sub> =1.2kΩ V <sub>CS</sub> : L→H R <sub>L3</sub> =1.4kΩ	111.2	114.4	117.6	mV
Output inversion voltage 2 (rated current control)	V <sub>CS2</sub>	V <sub>CC</sub> =2.0V V <sub>OUT</sub> =0V R <sub>L1</sub> =500Ω V <sub>REF</sub> =1.2V R <sub>L2</sub> =1.2kΩ V <sub>CS</sub> : L→H R <sub>L3</sub> =1.4kΩ	22	34		mV
CS input current	I <sub>CS</sub>	V <sub>OUT</sub> =5.0V V <sub>REF</sub> =1.2V V <sub>CS</sub> =0.1V		15	100	nA
Power supply voltage removal	PSRR2	V <sub>CC</sub> =4V→12V V <sub>REF</sub> =1.2V V <sub>CS</sub> =V <sub>CS1</sub> -10mV R <sub>L2</sub> =5kΩ	60	70		dB
P01 output inflow current	I <sub>PO1-I</sub>	V <sub>OUT</sub> =4.7V V <sub>REF</sub> =1.2V V <sub>CS</sub> =0.2V V <sub>PO1</sub> =0.5V	5	17		mA
<b>Input/output error control</b>						
Input/output error control voltage	ΔV <sub>LS</sub>	R <sub>S</sub> =4.7kΩ R <sub>O</sub> =5kΩ R <sub>L</sub> =100Ω	140	200	260	mV
CNT output inflow current	I <sub>CNT</sub>	V <sub>OUT</sub> =4.7V V <sub>REF</sub> =1.2V V <sub>CS</sub> =0V V <sub>CNT</sub> =0.8V	5	30		mA
OUT input current	I <sub>OUT</sub>	V <sub>OUT</sub> =5.0V V <sub>REF</sub> =1.2V V <sub>CS</sub> =0V		2	100	nA
<b>Load detection</b>						
Load detection voltage	ΔV <sub>LSP1</sub>	V <sub>OUT</sub> =5.0V→L R <sub>L1</sub> =500Ω V <sub>REF</sub> =1.2V R <sub>L2</sub> =1kΩ V <sub>CS</sub> =0V R <sub>L3</sub> =100Ω	170	200	230	mV
Energy-saving detection voltage (load detection release voltage)	ΔV <sub>LSP2</sub>	V <sub>OUT</sub> =L→5.0V R <sub>L1</sub> =500Ω V <sub>REF</sub> =1.2V R <sub>L2</sub> =1kΩ V <sub>CS</sub> =0V R <sub>L3</sub> =100Ω	97	115	133	mV
Voltage drop detection	V <sub>REFL</sub>	V <sub>OUT</sub> =5.0V R <sub>L1</sub> =500Ω V <sub>REF</sub> =1.2V→L R <sub>L2</sub> =1kΩ V <sub>CS</sub> =0V R <sub>L3</sub> =100Ω	0.975	1.000	1.025	V
PO2 output inflow current	I <sub>PO2</sub>	V <sub>OUT</sub> =4.7V V <sub>REF</sub> =1.2V V <sub>CS</sub> =0V V <sub>PO2</sub> =0.5V	5.0	93.0		mA

Operation Description

MM1529 Block Diagram

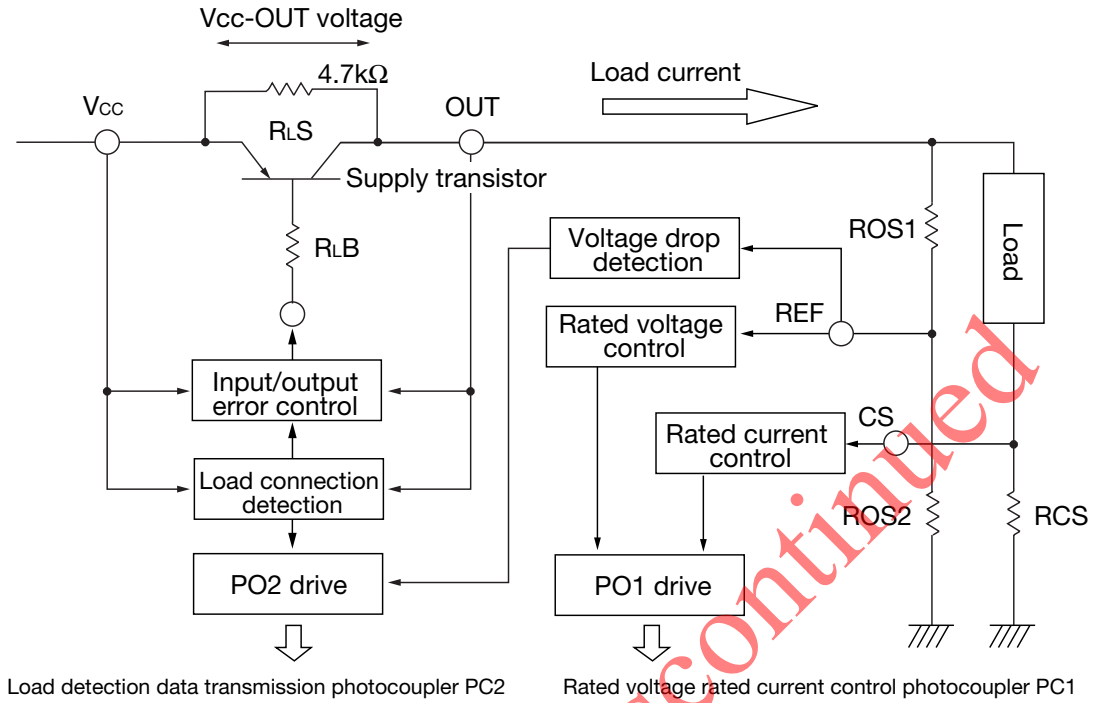

1. Description of Blocks

- (1) Input/output error control      Controls Tr base current supplied from the CNT pin when load is detected and the voltage between Vcc-OUT (supply Tr VCE voltage) falls below the setting voltage  $\Delta VLS$  (200mV).
- (2) Load connection detection      PO2 pin goes from OPEN to LOW when load current is the same as setting voltage  $\Delta VLSP1$  (200mV) and photocoupler PC2 goes on. This releases AC adaptor primary side switching prohibition and supply status begins. Also, detection voltage is changed in load current increasing and decreasing directions. (hysteresis :  $\Delta VLSP1 = 200mV \leftrightarrow \Delta VLSP2 = 115mV$ )
- (3) Voltage drop detection          In order to carry out intermittent oscillation on the secondary side, in energy-saving mode (load 30μA or less), the setting is such that energy-saving detection is released when REF pin voltage = 1.0V or less (when output voltage reaches 4V when set at 5V). This causes secondary side output voltage to oscillate intermittently between 5V ↔ 4V.
- (4) Rated current control            When voltage between CS and GND pins reaches setting voltage VCS1 (0.1144V), external rated current detection resistor RCS causes P01 pin to go from OPEN to LOW, and rated voltage rated current control photocoupler PC1 goes on. This starts CC mode and controls VCS1 voltage to 0.1144V.
- (5) Rated voltage control            Controls P01 so that REF pin voltage = 1.25V. This starts CV mode.

## 2. Mode Settings

AC adaptors using MM1529 have the following four mode controls. Mode switching design is explained below.

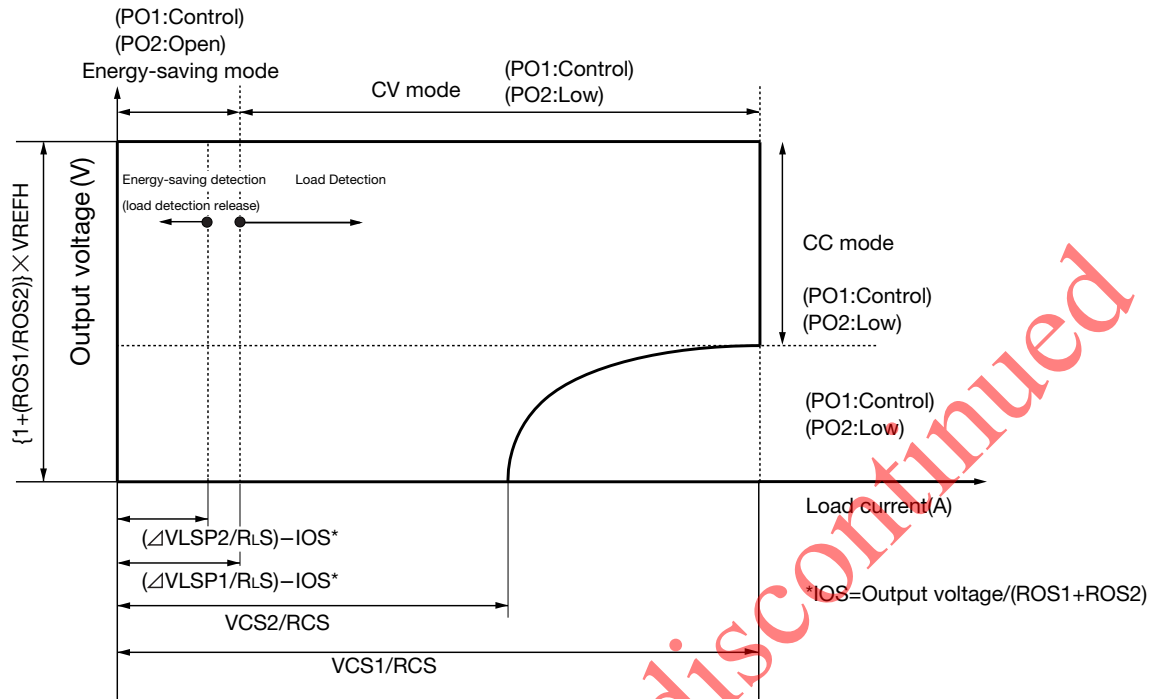

### (1) Load detection/Energy-saving detection (RLS adjustment method)

Load detection current and energy-saving detection current can be set by load detection resistor R<sub>LS</sub>. When used at 4.7kΩ, it is designed to switch when current flowing on R<sub>LS</sub> is > 43μ. However, R<sub>OS1</sub> and R<sub>OS2</sub> currents must be subtracted for actual detection. (Must be subtracted from Graph 1 results.)

[Calculation formula] Load detection current =  $(\Delta VLSP1/R_{LS}) - (\text{output voltage}/(R_{OS1} + R_{OS2}))$   
 Energy-saving detection current =  $(\Delta VLSP2/R_{LS}) - (\text{output voltage}/(R_{OS1} + R_{OS2}))$

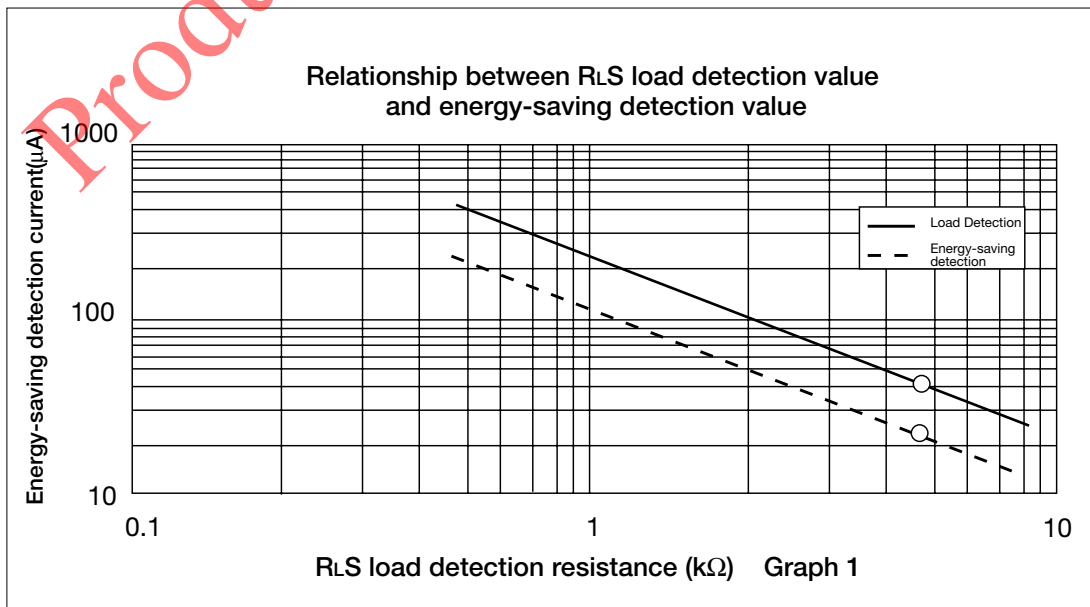

(2) Rated current detection (RCS adjustment method)

Rated current control value can be set by rated current detection resistor RCS.  
 When used at 0.22Ω, it is designed to switch to rated current operation at 520mA.

[Calculation formula]      Rated current control =  $VCS1/RCS$       ( $VCS1 = 0.1144V$ )

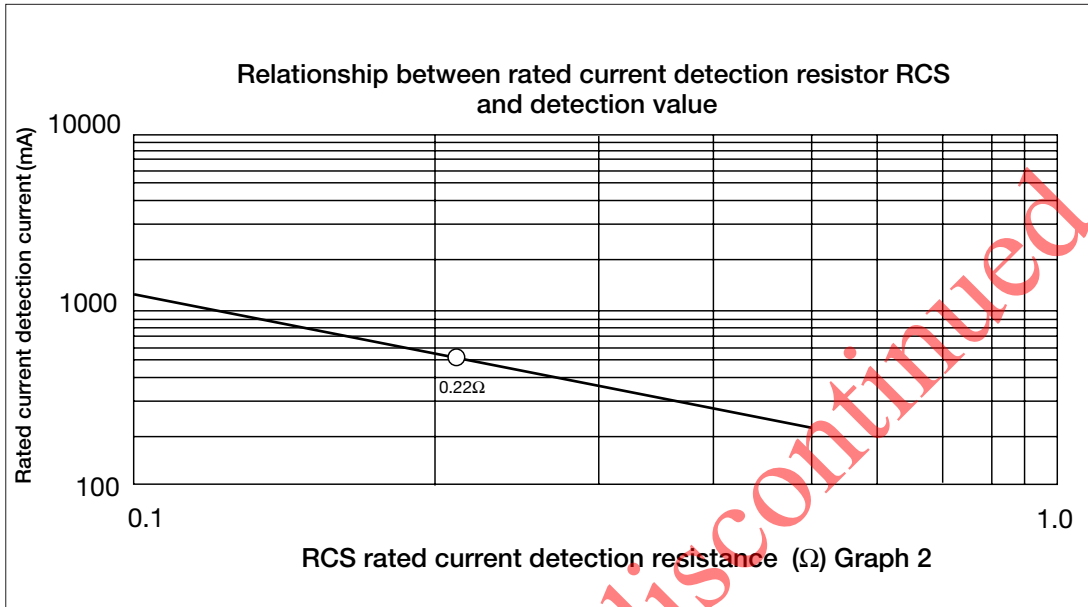

(3) Output voltage (R0S1, R0S2 adjustment method)

Precautions with regard to R0S1 and R0S2 output voltage detection resistance

The REF pin is controlled to 1.25V, so output voltage can be designed using the resistance ratio between R0S1 and R0S2. At this time, R0S1 + R0S2 current is that added to load detection, so it must be set lower than load detection current.

[Calculation formula]      Output voltage =  $\{1 + (R0S1/R0S2)\} \times 1.25$

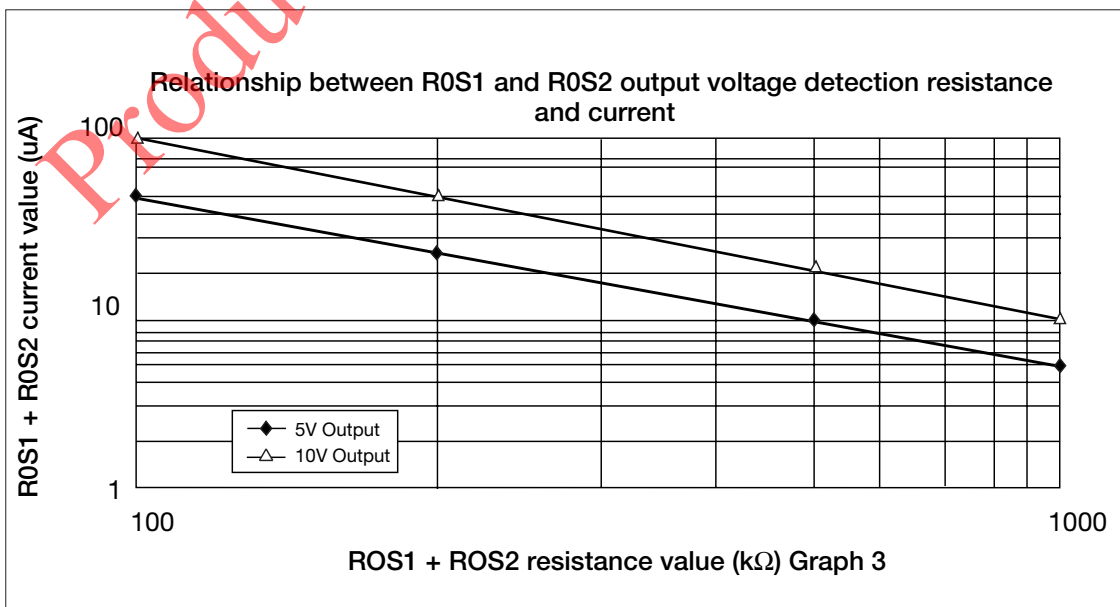



■ Load Detection

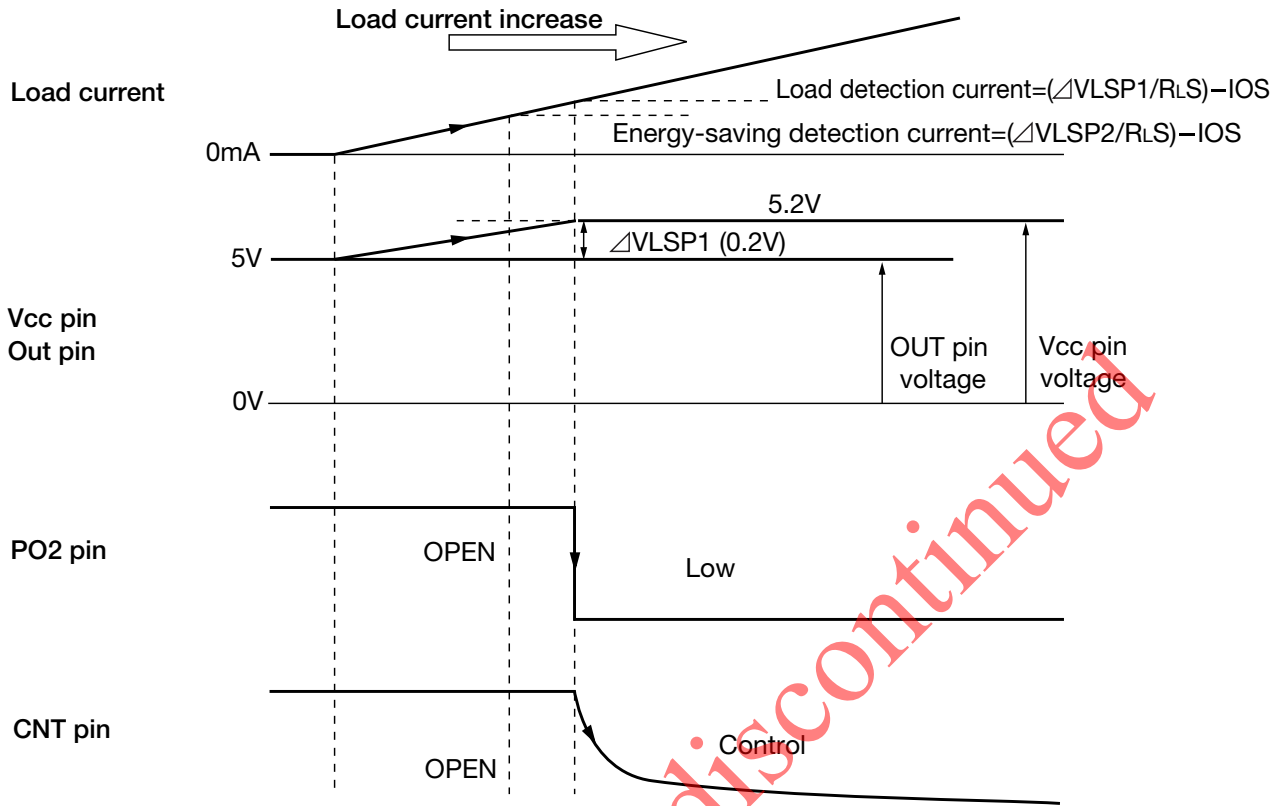

■ Energy-saving Detection (load detection release)

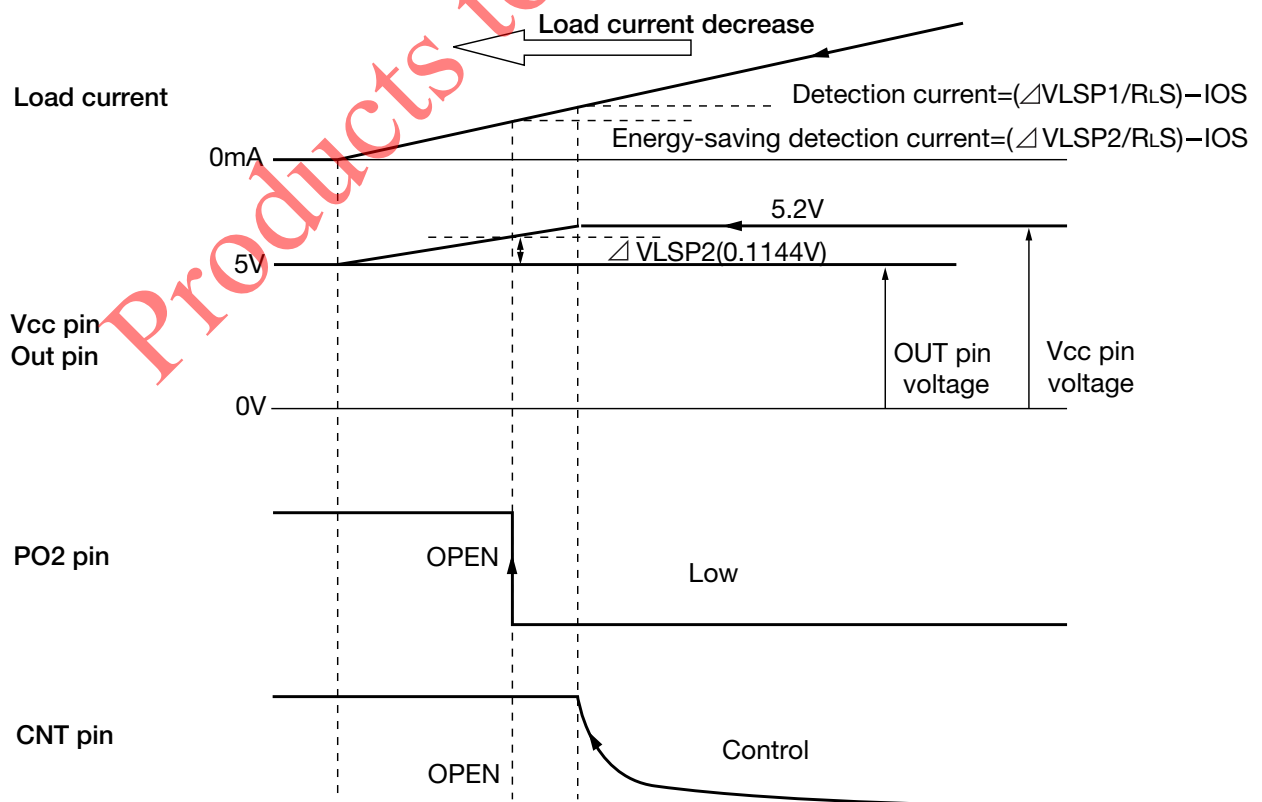

Application Circuit

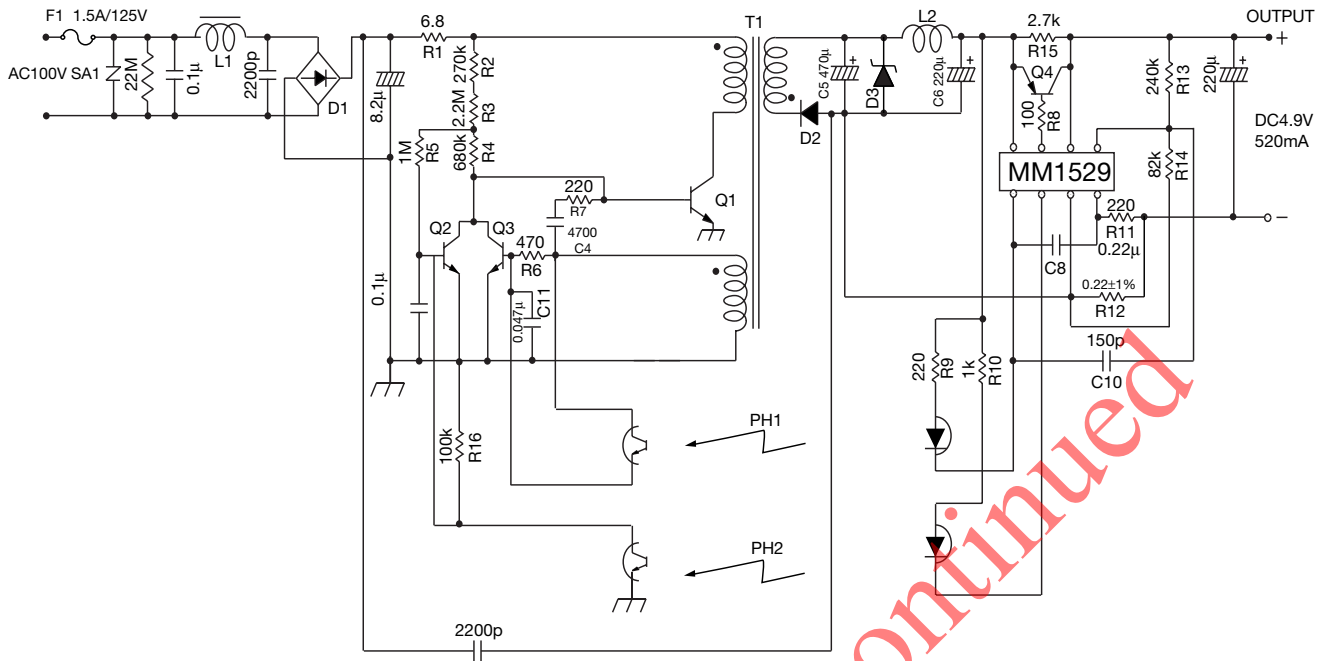

Products to be discontinued

Characteristics Diagram

PO1 pin current characteristics

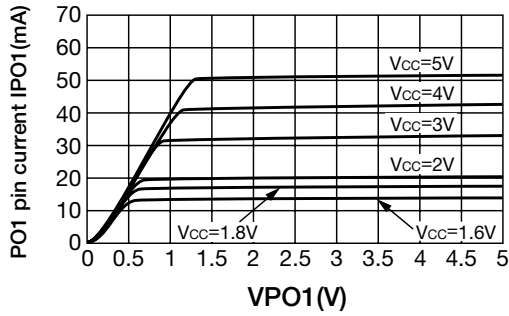

PO2 pin current characteristics

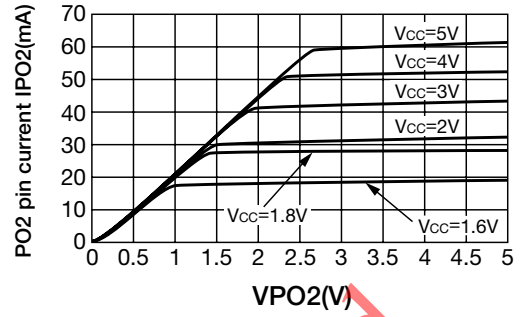

CNT pin current characteristics

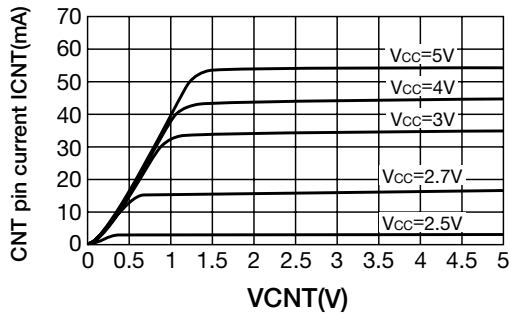

Reference voltage - current voltage characteristics

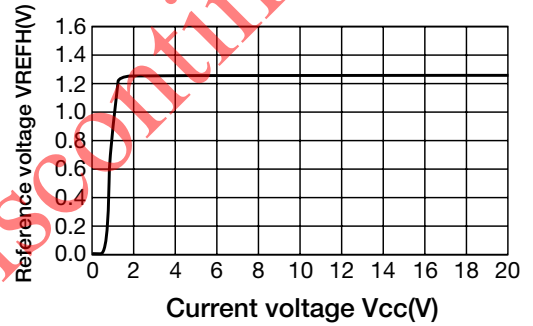

Reference voltage temperature response (VCC=5V)

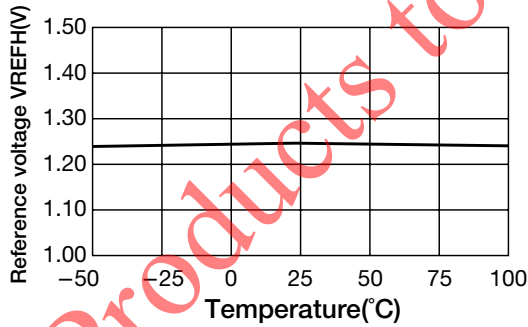

Current consumption 1 (energy-saving) temperature response (VCC=5V)

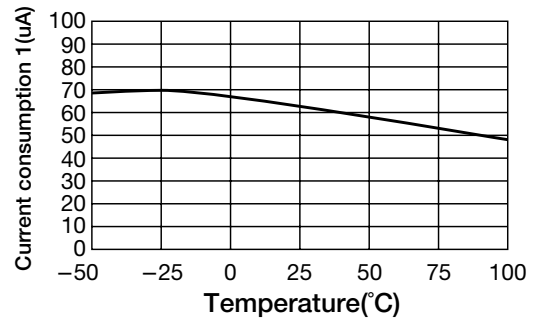

Current consumption 2 temperature response (VCC=5V)

