

Temperature Switch IC with Hysteresis

Monolithic IC MM3496

Outline

This IC is a temperature switch IC that senses an ambient temperature around the IC and changes the IC output level when the temperature around the IC reaches the detection temperature. With the hysteresis function, IC output level returns to the state before detection when the ambient temperature returns to the hysteresis temperature selected after detection. Detection temperature (T_{DET}) can be selected in 1.0°C steps within the range of -20 to +90°C, with detection temperature accuracy (T_{DETAC1}) of $\pm 2.0^\circ\text{C}$.

Features

1. Low current consumption
2. High Temperature accuracy
3. Comes with hysteresis function
4. Small package

Package

SSON-4B

Applications

1. Cellular phones
2. Flat Panel Displays
3. Game equipment
4. PCs
5. System thermal monitors
6. Office Automation equipment

Model Name

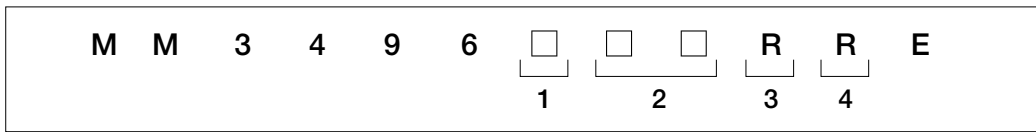

MM3496A□□RRE, MM3496B□□RRE, MM3496C□□RRE

1		2	
Hysteresis Temperature (T _{HYS}) (Note1)		Detecting Temperature (T _{DET}) (Note1)	
A	T _{HYS} =+5.0°C	25	T _{DET} =+25°C
B	T _{HYS} =+10°C	∓	T _{DET} is +1.0°C steps
C	T _{HYS} =+15°C	90	T _{DET} =+90°C

MM3496D□□RRE, MM3496E□□RRE, MM3496F□□RRE

1		2	
Hysteresis Temperature (T _{HYS}) (Note1)		Detecting Temperature (T _{DET}) (Note1)	
D	T _{HYS} =-5.0°C	00	T _{DET} =+0.0°C
E	T _{HYS} =-10°C	∓	T _{DET} is +1.0°C steps
F	T _{HYS} =-15°C	24	T _{DET} =+24°C

MM3496G□□RRE, MM3496H□□RRE, MM3496I□□RRE

1		2	
Hysteresis Temperature (T _{HYS}) (Note1)		Detecting Temperature (T _{DET}) (Note1)	
G	T _{HYS} =-5.0°C	01	T _{DET} =-1.0°C
H	T _{HYS} =-10°C	∓	T _{DET} is -1.0°C steps
I	T _{HYS} =-15°C	20	T _{DET} =-20°C

3		4	
Package		Packing Specifications	
R	SSON-4B	R	R HOUSING (Standard)
		L	L HOUSING

Note1 : Refer to [10. TIMING CHART] for the definition of the Hysteresis Temperature and the Detecting Temperature.

Block Diagram

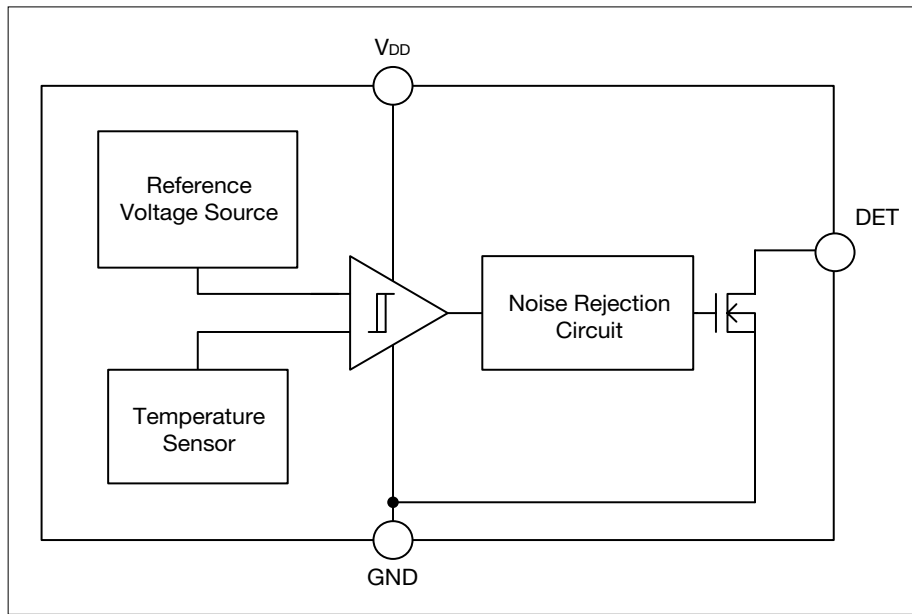

Pin Assignment

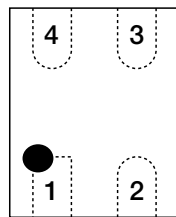

SSON-4B
(TOP VIEW)

1	DET
2	GND
3	NC
4	V _{DD}

Pin Description

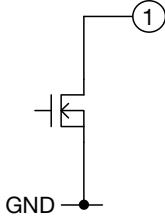
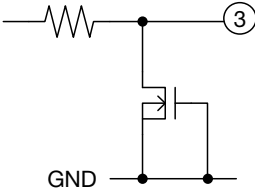
Pin No.	Pin Name	Function	Internal Equivalent Circuit
1	DET	Temp. Detect Output Pin	
2	GND	Ground pin	
3	NC (Note2)	NC (Testing pin)	
4	V _{DD}	Power supply pin	

Note2 : Testing pin is connected with the internal circuit for testing.

When resistance and capacity are connected with Testing pin, this product produce improper operating signals. Please set Testing pin to the open state.

Absolute Maximum Ratings

Item	Symbol	Ratings	Units
Maximum Supply Voltage	V _{DDmax}	-0.3~+6.0	V
Terminal Voltage	DET _{max}	-0.3~+6.0	V
Storage Temperature	T _{stg}	-55~+150	°C
Power Dissipation	P _d	150	mW

Recommended Operating Conditions

Item	Symbol	Ratings	Units
Operating Supply Voltage	V _{DDopr}	2.2~5.0	V
Operating Temperature	T _{opr}	-30~+125	°C

Electrical Characteristics (Except where noted otherwise Ta=25°C, VDD=2.8V)

Item	Symbol	Measurement conditions	Min.	Typ.	Max.	Units
Detecitng Temperature Accuracy (Note3)	T _{DETAC1}		-2.0	0	+2.0	°C
Hysteresis Temperature (Note4)	T _{HYS}	T _{HYS} =5.0°C		5.0		°C
		T _{HYS} =10°C		10.0		°C
		T _{HYS} =15°C		15.0		°C
DET Sink Current	I _{DETL}	V _{DET} =0.4V V _{DET} =Low Level	4.0	12.0		mA
DET Leak Current	I _{LEAK}	V _{DD} =5.0V V _{DET} =High Level			0.1	μA
Supply Current	I _{DD}			1.5	3.5	μA
Noise Rejection Time	t _{noise}	Ta=60~90°C		250	500	μs
V _{DD} Start-up Response	t _{vsr}	R _{PULL-UP} = 1MΩ		100	500	μs

Note3 : Detection temperature can be selected in 1.0°C steps

Note4 : Hysteresis temperature can be selected in 5.0°C steps

Timing Chart

Detecting Temperature ($T_{DET} \geq +25^{\circ}C$)

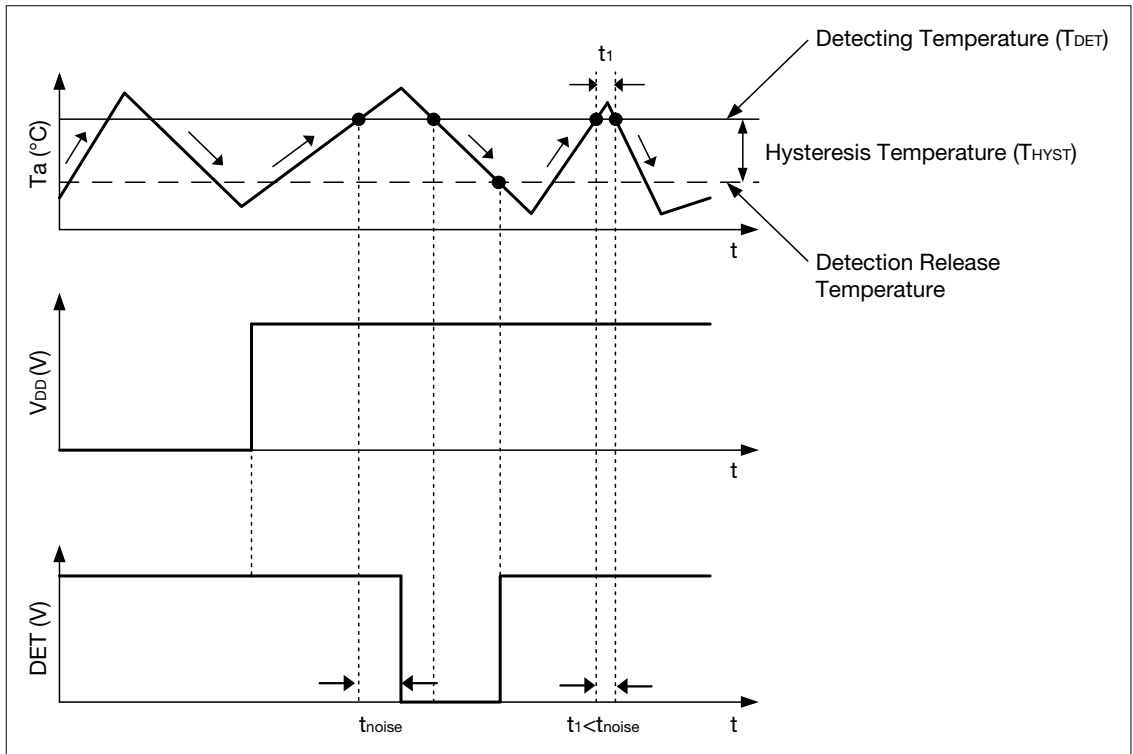

Detecting Temperature ($T_{DET} < +25^{\circ}C$)

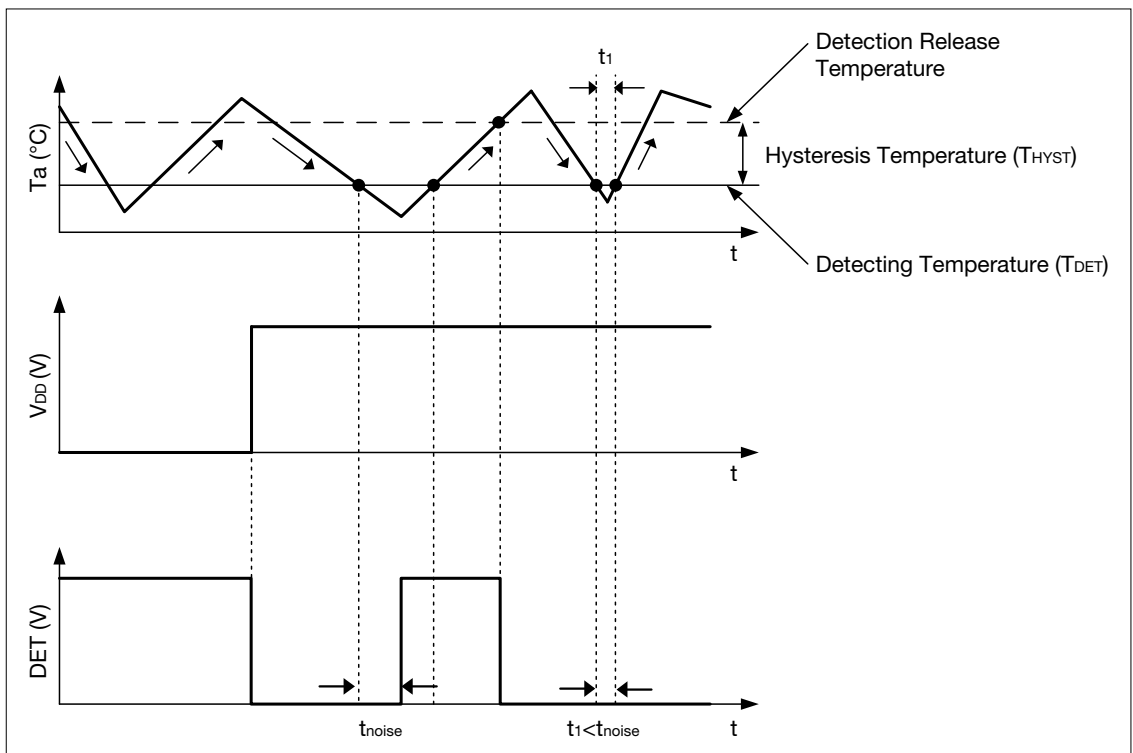

• Any products mentioned in this catalog are subject to any modification in their appearance and others for improvements without prior notification.
 • The details listed here are not a guarantee of the individual products at the time of ordering. When using the products, you will be asked to check their specifications.