

300mA LDO

Monolithic IC MM189x Series

Outline

This IC is a Low noise 300mA LDO.

The output voltage line-up is 1.5-5V (0.1V step) and a adjustable type.

A protection function is built in a current limiter and a thermal shutdown.

The applications is for standard power supply of home equipment by SOT89-5 package.

Features

1. Output current	300mA
2. No load input current	85µA typ.
3. Input current (OFF)	0.1µA max.
4. Output voltage range	1.5-5.0V (0.1V step)
5. Output voltage accuracy	±1.5%
6. Dropout voltage	0.12V typ. (I _o =150mA)
7. Line regulation	10mV typ. (V _{in} =V _o +1.5-2.5V)
8. Load regulation	15mV typ. (I _o =0~300mA)
9. Ripple rejection	70dB typ. (f=120Hz)
10. Output noise voltage	30µV _{rms} typ. (C _n =0.01µF)
11. Output Capacitor	1µF (Ceramic)

Package

SOT89-5

Applications

1. TVs
2. DVD, BD-Players, Recorders
3. Games

Block Diagram

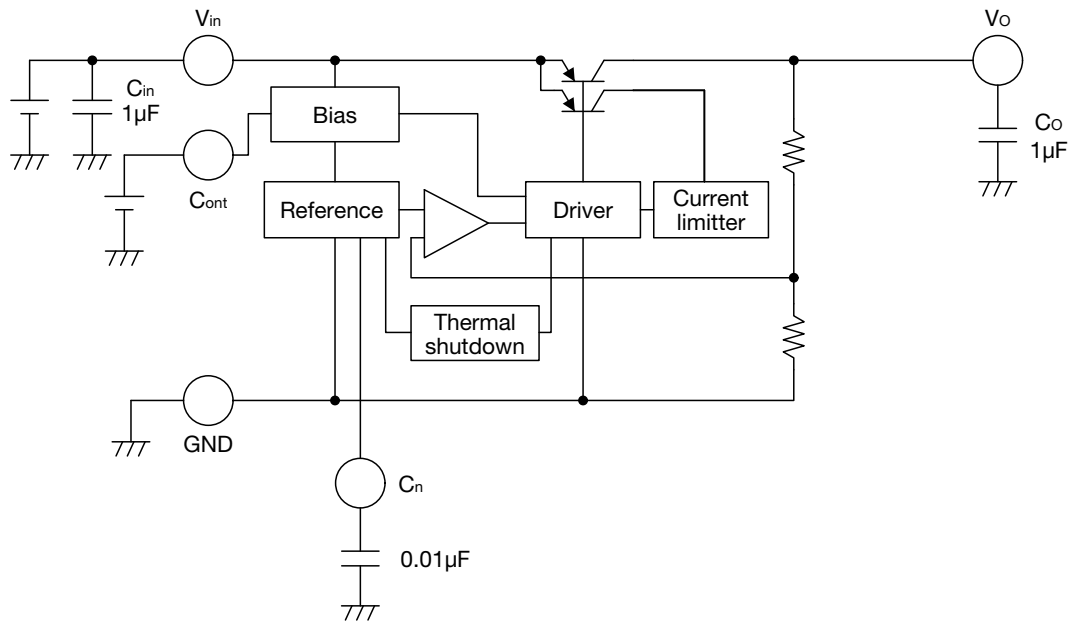

Pin Assignment

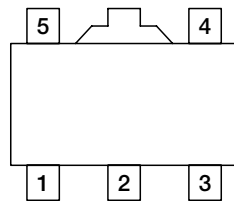

SOT89-5
(TOP VIEW)

1	C _n
2	GND
3	Cont
4	V _{in}
5	V _o

Pin Description

Pin No.	Pin name	Functions	Internal equivalent circuit diagram			
1	Cn	<p>Noise decrease pin</p> <p>Connecting 0.01μF capacitor can decrease output noise. If the noise decrease capacitor is not connected, the pin may be influenced by outside noise.</p>				
2	GND	Ground				
3	Cont	<p>ON/OFF Control pin</p> <table border="1" style="margin-left: 20px;"> <tr> <td>Cont</td> </tr> <tr> <td>H</td> </tr> <tr> <td>L</td> </tr> </table> <p>Cont pin must be connected with Vin pin, if it is not used.</p>	Cont	H	L	
Cont						
H						
L						
4	V _{in}	<p>Input pin</p> <p>The capacitor is required to connect with input pin more than 1μF.</p>				
5	V _o	<p>Output pin</p> <p>The capacitor must be connected with output pin more than 1μF.</p>				

• Any products mentioned in this catalog are subject to any modification in their appearance and others for improvements without prior notification.
 • The details listed here are not a guarantee of the individual products at the time of ordering. When using the products, you will be asked to check their specifications.

Absolute Maximum Ratings (Except where noted otherwise Ta=25°C)

Item	Symbol	Ratings	Units
Storage Temperature	T _{stg}	-55~+150	°C
Operating Temperature	T _{opr}	-40~+85	°C
Supply Voltage	V _{in}	-0.3~+13.2	V
Max Output Current	I _{out}	400	mA
Power Dissipation	P _d	690(Note1)	mW

Note1 : With the PC Board of glass epoxy.
(50 × 50 × 1.6mm)

Recommended Operating Conditions (Except where noted otherwise Ta=25°C)

Item	Symbol	Ratings	Units
Output Current	I _{out}	0~300	mA
Operating Voltage	V _{op}	2.2~12.6	V

Electrical Characteristics 1 (Except where noted otherwise V_{in}=V_o(typ.)+1V, I_o=1mA, V_{cont}=1.6V, Ta=25°C)

Item	Symbol	Measurement conditions	Min.	Typ.	Max.	Units
No-Load Input Current	I _{cc}	I _o =0mA		85	140	μA
Input Current(OFF)	I _{ccoff}	V _{cont} =0V		0	0.1	μA
Output Voltage (Note3)	V _{OUT}	I _o =1mA	×0.985		×1.015	V
Dropout Voltage (Note4)	V _{io}	V _{in} =V _o -0.2V, I _o =150mA		0.12	0.24	V
Line Regulation	ΔV1	V _{in} =V _o +1.5~V _o +2.5V, I _o =1mA		10	20	mV
Load Regulation	ΔV2	I _o =0~300mA		15	60	mV
V _{OUT} Temperature Coefficient (Note2)	ΔV _{OUT} /ΔT	T _j =-40~+85°C		±100		ppm/°C
Ripple Rejection (Note2)	RR	f=120Hz V _{ripple} =1V, I _o =100mA	50	70		dB
Output Noise Voltage (Note2)	V _n	f _{BW} =20~80kHz, C _n =0.01μF, I _{out} =100mA		30		μV _{rms}
		f _{BW} =20~80kHz, C _n =OPEN, I _{out} =100mA		150		
Cont Pin Input Current	I _{cont}		10	20	30	μA
Cont Pin High Threshold Level	V _{contH}		1.6		V _{in} +0.3	V
Cont Pin Low Threshold Level	V _{contL}		-0.3		0.4	V

Note2 : The parameter is guaranteed by design.

Note3 : Please refer to another page.

Note4 : The parameter is not guaranteed in the model less than V_{OUT}=2V.

Electrical Characteristics 2 (Except where noted otherwise $V_{in}=V_o(\text{typ.})+1V$, $I_o=1mA$, $V_{cont}=1.6V$, $T_a=25^\circ C$)

Model No.	Measurement Conditions	Output Voltage (V)		
		Min.	Typ.	Max.
MM1891F	I _o =1mA	1.478	1.5	1.523
MM1891G		1.576	1.6	1.624
MM1891H		1.675	1.7	1.726
MM1891J		1.773	1.8	1.827
MM1891K		1.872	1.9	1.929
MM1892A		1.970	2.0	2.030
MM1892B		2.069	2.1	2.132
MM1892C		2.167	2.2	2.233
MM1892D		2.266	2.3	2.335
MM1892E		2.364	2.4	2.436
MM1892F		2.463	2.5	2.538
MM1892G		2.561	2.6	2.639
MM1892H		2.660	2.7	2.741
MM1892J		2.758	2.8	2.842
MM1892K		2.857	2.9	2.944
MM1893A		2.955	3.0	3.045
MM1893B		3.054	3.1	3.147
MM1893C		3.152	3.2	3.248
MM1893D		3.251	3.3	3.350
MM1893E		3.349	3.4	3.451
MM1893F		3.448	3.5	3.553
MM1893G		3.546	3.6	3.654
MM1893H		3.645	3.7	3.756
MM1893J		3.743	3.8	3.857
MM1893K		3.842	3.9	3.959
MM1894A		3.940	4.0	4.060
MM1894B		4.039	4.1	4.162
MM1894C		4.137	4.2	4.263
MM1894D		4.236	4.3	4.365
MM1894E		4.334	4.4	4.466
MM1894F		4.433	4.5	4.568
MM1894G		4.531	4.6	4.669
MM1894H		4.630	4.7	4.771
MM1894J	4.728	4.8	4.872	
MM1894K	4.827	4.9	4.974	
MM1895A	4.925	5.0	5.075	

• Any products mentioned in this catalog are subject to any modification in their appearance and others for improvements without prior notification.
 • The details listed here are not a guarantee of the individual products at the time of ordering. When using the products, you will be asked to check their specifications.

Measuring Circuit

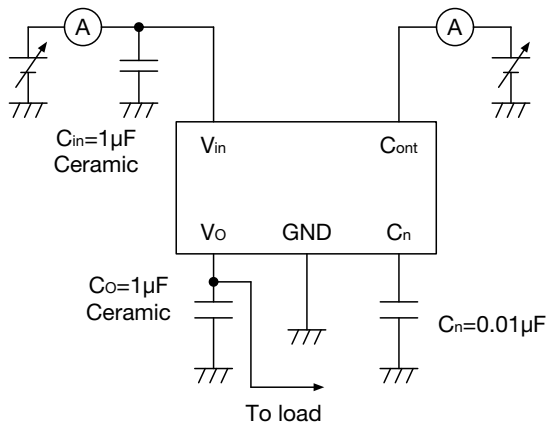

Application Circuit

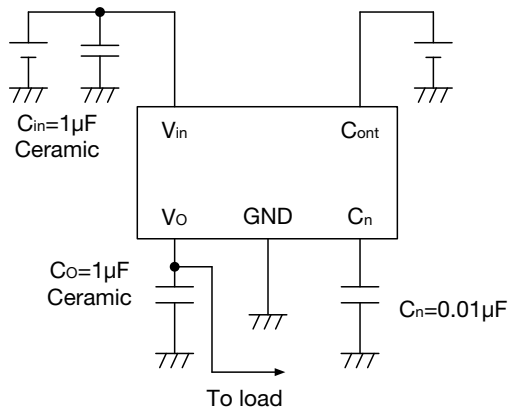

★ Temperature Characteristics : B Type

· Note

1. The output capacitor is required between output and GND to prevent oscillation.
2. The ESR of capacitor must be defined in ESR stability area.
It is possible to use a ceramic capacitor without ESR resistance for output.
The ceramic capacitor must be used more than 1µF and B type temperature characteristics.
3. The wire of Vcc and GND is required to print full ground plane for noise and stability.
4. The input capacitor must be connected a distance of less than 1cm from input pin.
5. In case the output voltage is above the input voltage, the overcurrent flow by internal parasitic diode from output to input. In such application, the external bypass diode must be connected between output and input pin.
6. The heatsink(Tab) pin must be connected with GND.

Characteristics (Vo=2.8V) (Except where noted otherwise Ta=25°C, Vin=Vo+1V, Vcont=1.6V, Cin=1µF, Co=1µF, Cn=0.01µF)

Output - Input voltage

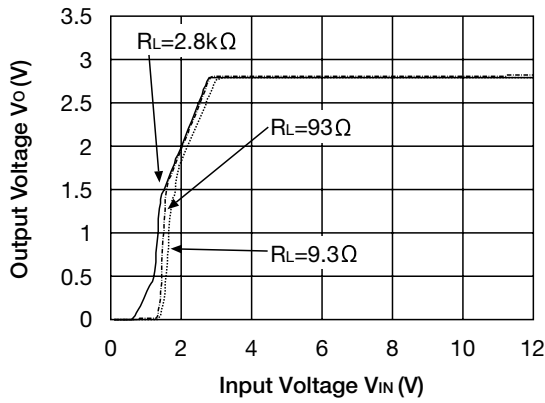

Input current - Input voltage

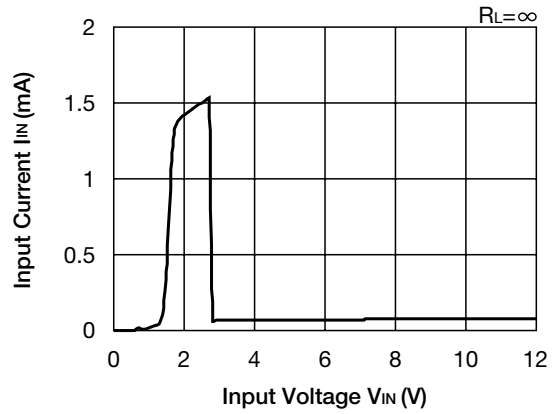

Load regulation

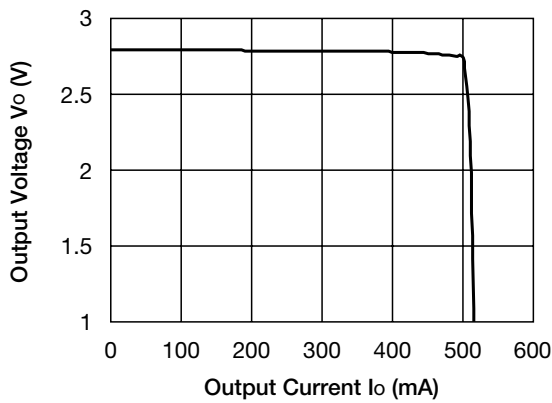

Line regulation

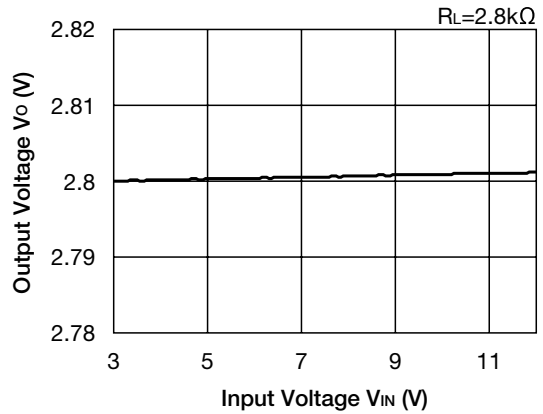

Dropout voltage - Output current

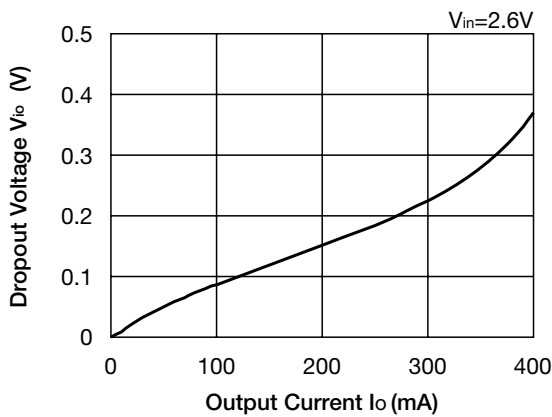

Output voltage - Ambient temperature

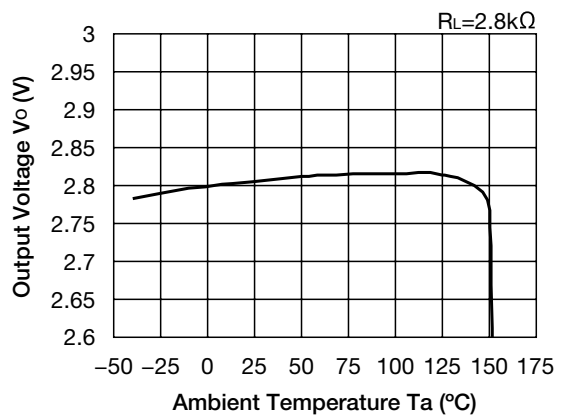

• Any products mentioned in this catalog are subject to any modification in their appearance and others for improvements without prior notification.
 • The details listed here are not a guarantee of the individual products at the time of ordering. When using the products, you will be asked to check their specifications.

Ripple Rejection

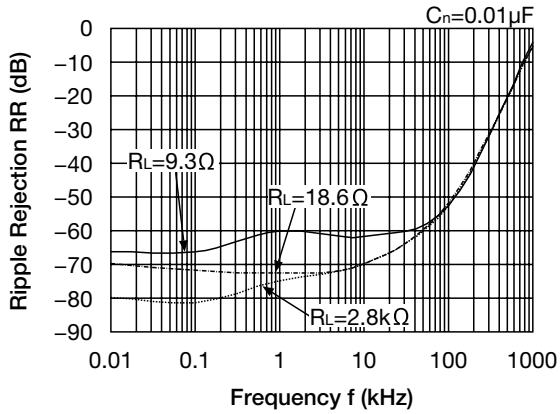

Ripple Rejection

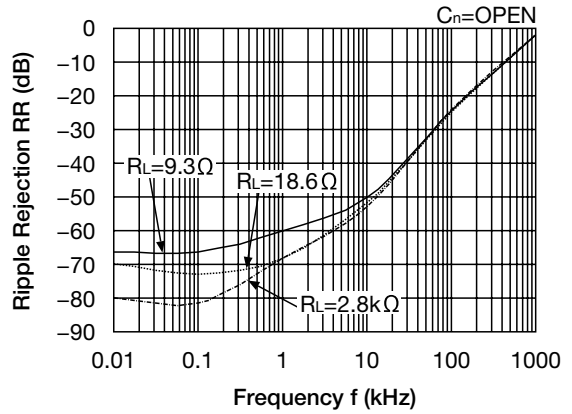

GND pin current

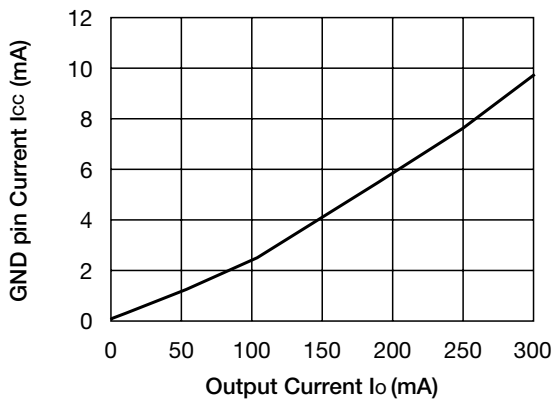

Output noise voltage

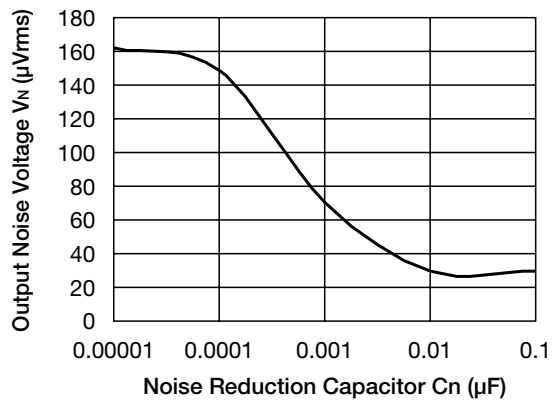

ESR Stable area

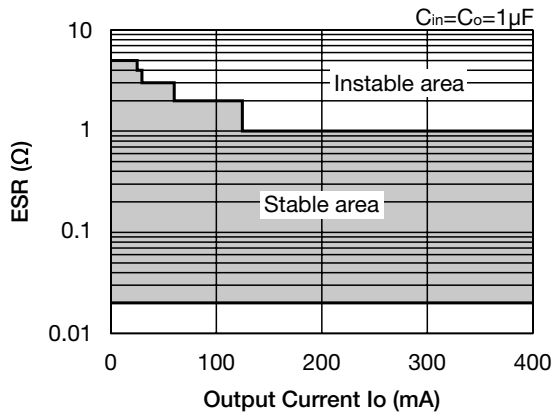

ESR Stable area

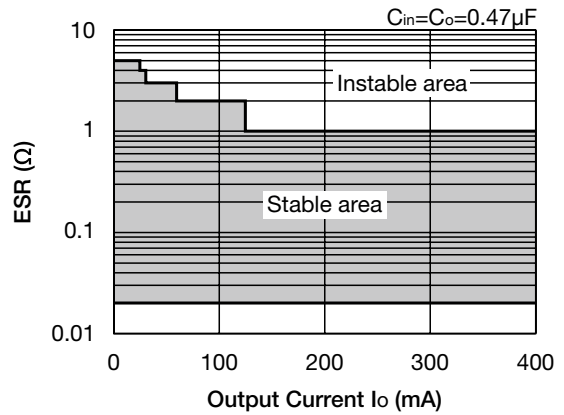

• Any products mentioned in this catalog are subject to any modification in their appearance and others for improvements without prior notification.
 • The details listed here are not a guarantee of the individual products at the time of ordering. When using the products, you will be asked to check their specifications.

■ Load transient response ($I_o=0 \rightarrow 300\text{mA}$)

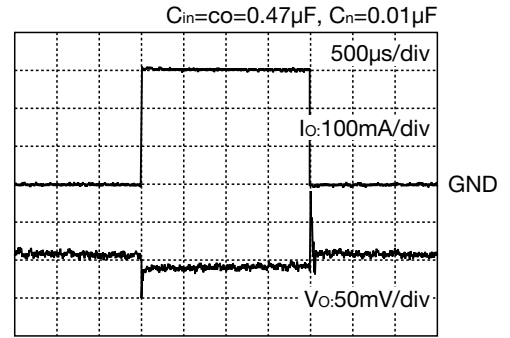
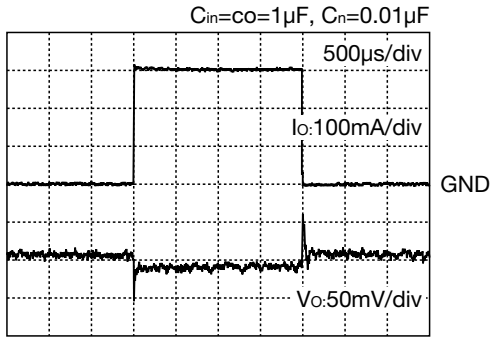

■ Line transient response ($V_{in}=0 \rightarrow 4.8\text{V}, I_o=300\text{mA}$)

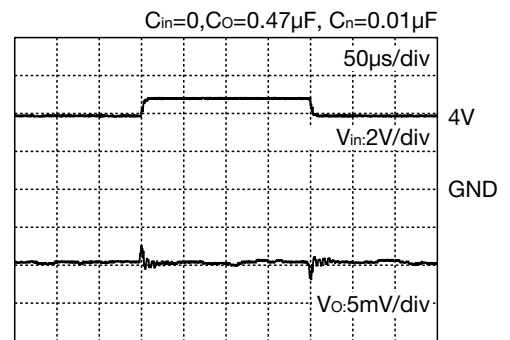
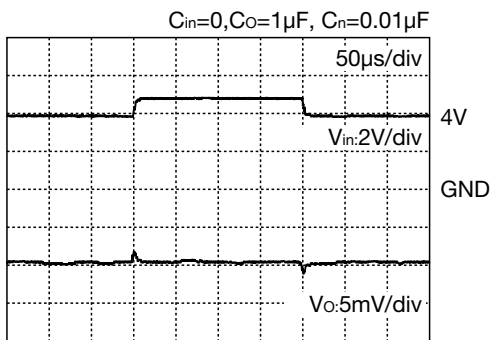

■ Turn-On transient response

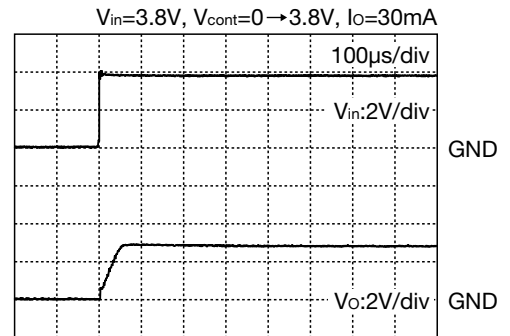
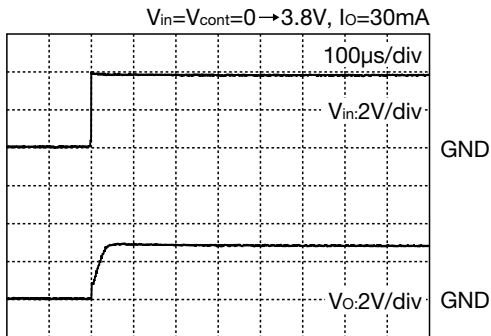

Characteristics (Vo=1.8V) (Except where noted otherwise Ta=25°C, Vin=Vo+1V, Vcont=1.6V, Cin=1μF, Co=1μF, Cn=0.01μF)

Output - Input voltage

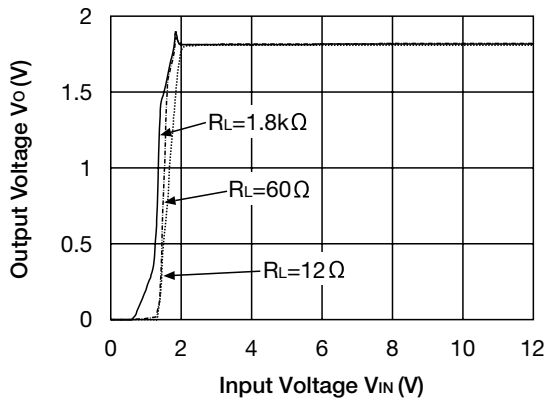

Load regulation

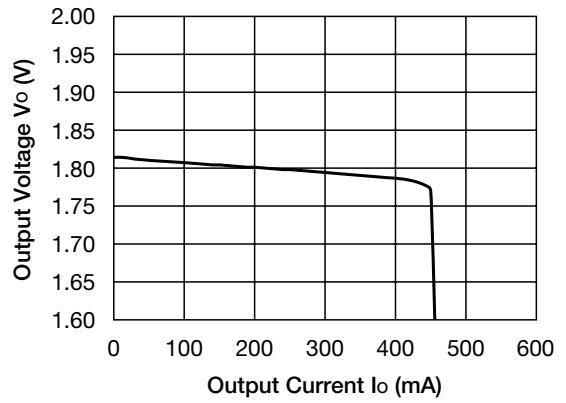

Line regulation

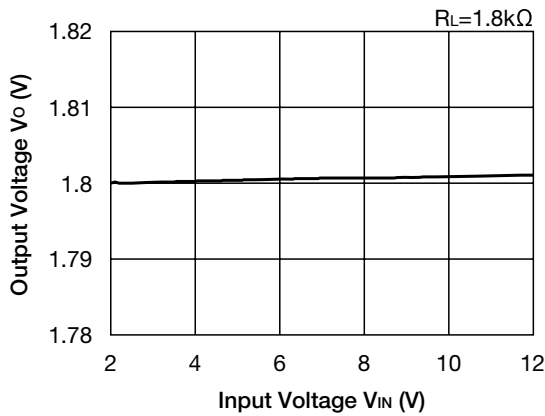

Output voltage - Ambient temperature

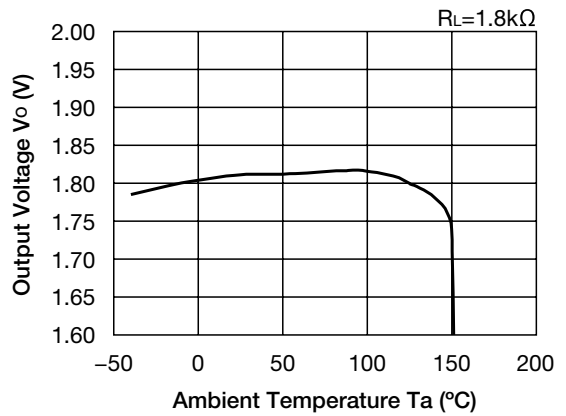

ESR Stable area

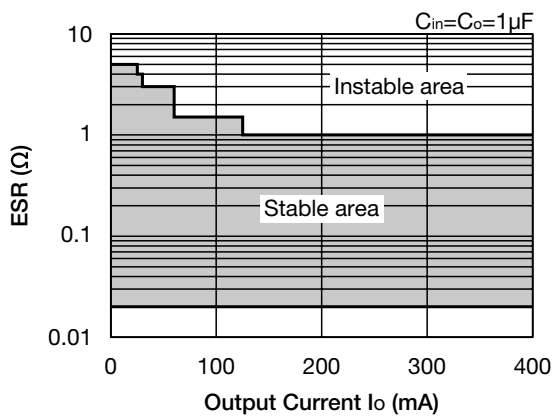

ESR Stable area

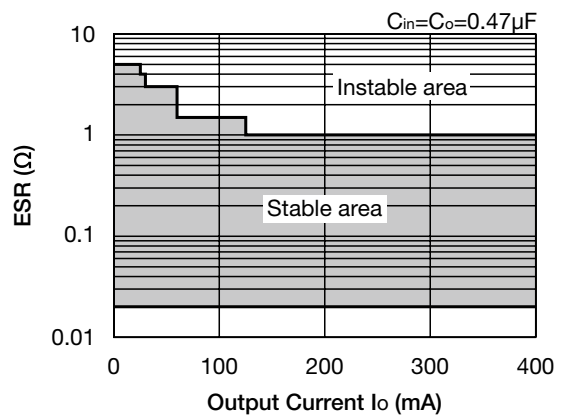

• Any products mentioned in this catalog are subject to any modification in their appearance and others for improvements without prior notification.
 • The details listed here are not a guarantee of the individual products at the time of ordering. When using the products, you will be asked to check their specifications.

Characteristics (Vo=3.3V) (Except where noted otherwise Ta=25°C, Vin=Vo+1V, Vcont=1.6V, Cin=1μF, Co=1μF, Cn=0.01μF)

Output - Input voltage

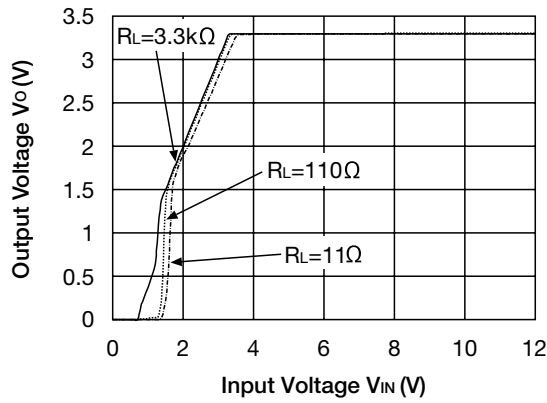

Load regulation

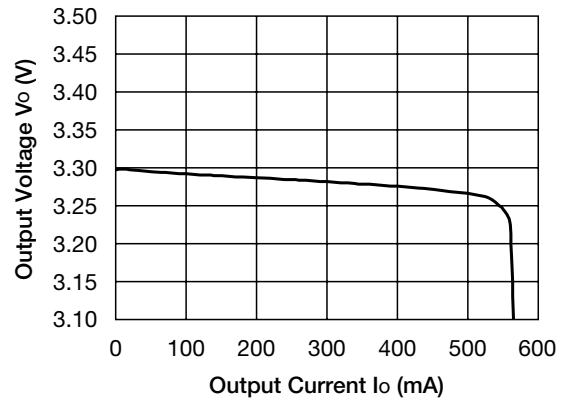

Line regulation

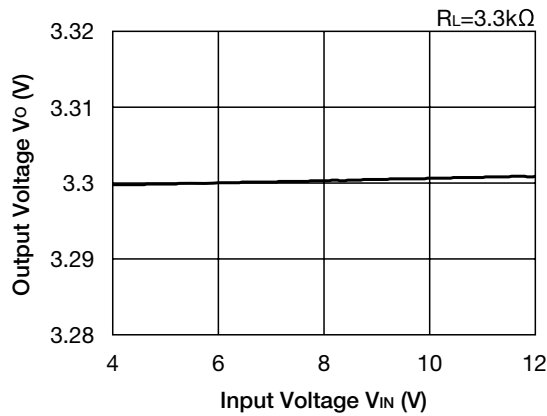

Output voltage - Ambient temperature

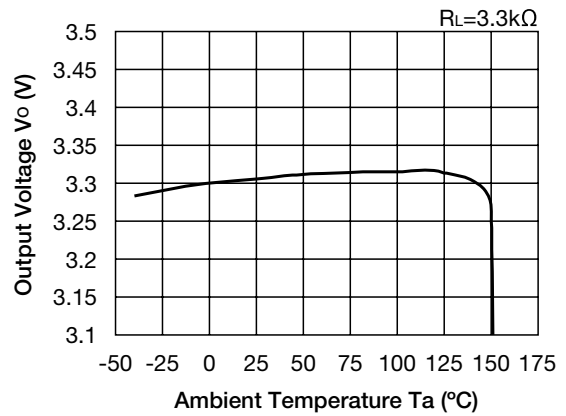

ESR Stable area

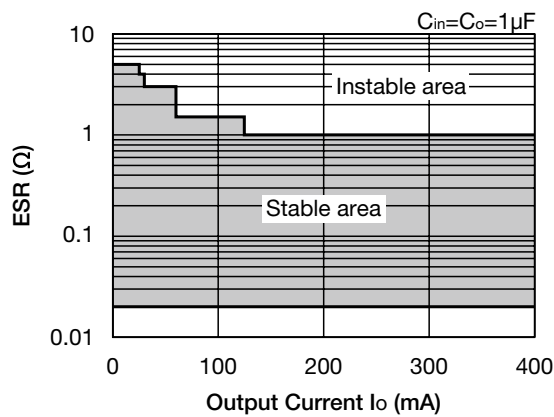

ESR Stable area

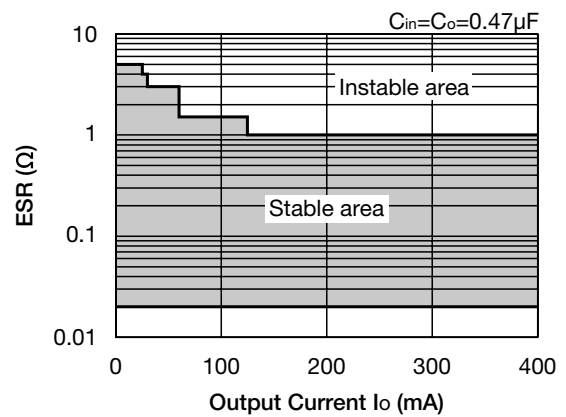

• Any products mentioned in this catalog are subject to any modification in their appearance and others for improvements without prior notification.
 • The details listed here are not a guarantee of the individual products at the time of ordering. When using the products, you will be asked to check their specifications.