

Transformers for DC-DC Converter C8-R, TR Series

C8-R4L

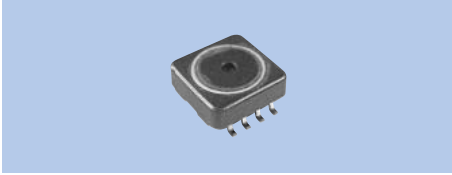

Specifications

- (1) -
- (2) 10~500kHz
- (3) 0.8W

Features

- SMD
- 1,000pcs./Reel

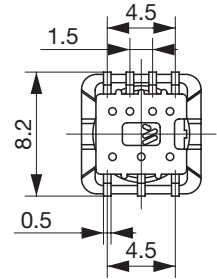
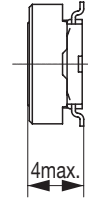
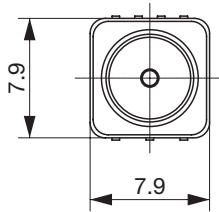

C8-R5L

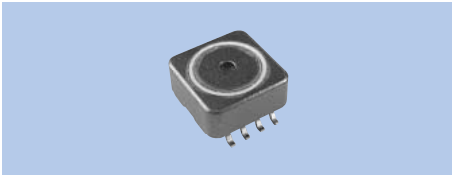

Specifications

- (1) -
- (2) 10~500kHz
- (3) 1.0W

Features

- SMD
- 1,000pcs./Reel

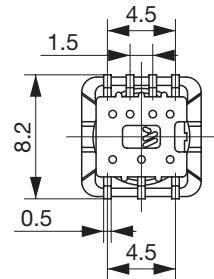
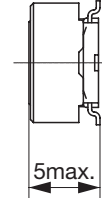
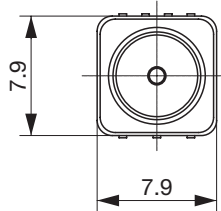

C8-R6L

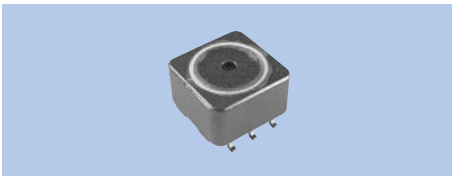

Specifications

- (1) -
- (2) 10~500kHz
- (3) 1.2W

Features

- SMD
- 1,500pcs./Reel

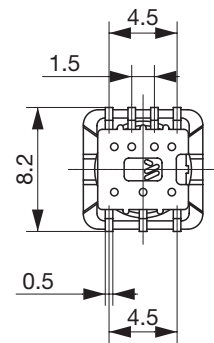
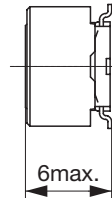
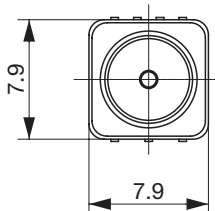

(1) Inductance
(2) Operational frequency
(3) Power capacity

TR11-A-S

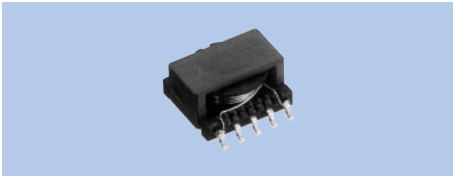

Specifications
 (1) –
 (2) 10~300kHz
 (3) 2W

Features
 SMD
 500pcs./Reel

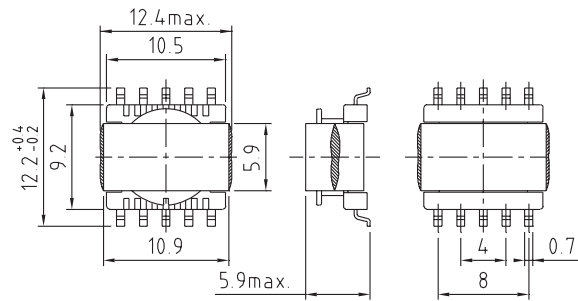

TR14-A-S

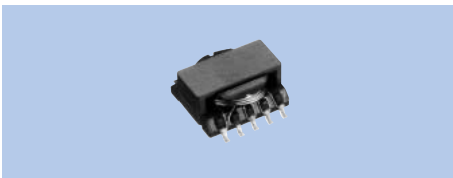

Specifications
 (1) –
 (2) 10~300kHz
 (3) 3.0W

Features
 SMD
 300pcs./Reel

